



REFERENCE MODEL

The *openEHR* EHR Information Model

Editors: {T Beale, S Heard}¹, {D Kalra, D Lloyd}²

Revision: 5.0

Pages: 83

-
1. Ocean Informatics Australia
 2. Centre for Health Informatics and Multi-professional Education, University College London

© 2003-2006 The *openEHR* Foundation

The *openEHR* foundation

is an independent, non-profit community, facilitating the creation and sharing of health records by consumers and clinicians via open-source, standards-based implementations.

Founding Chairman David Ingram, Professor of Health Informatics, CHIME, University College London

Founding Members Dr P Schloeffel, Dr S Heard, Dr D Kalra, D Lloyd, T Beale

email: info@openEHR.org **web:** <http://www.openEHR.org>

Copyright Notice

© Copyright openEHR Foundation 2001 - 2006
All Rights Reserved

1. This document is protected by copyright and/or database right throughout the world and is owned by the openEHR Foundation.
2. You may read and print the document for private, non-commercial use.
3. You may use this document (in whole or in part) for the purposes of making presentations and education, so long as such purposes are non-commercial and are designed to comment on, further the goals of, or inform third parties about, openEHR.
4. You must not alter, modify, add to or delete anything from the document you use (except as is permitted in paragraphs 2 and 3 above).
5. You shall, in any use of this document, include an acknowledgement in the form: "© Copyright openEHR Foundation 2001-2006. All rights reserved. www.openEHR.org"
6. This document is being provided as a service to the academic community and on a non-commercial basis. Accordingly, to the fullest extent permitted under applicable law, the openEHR Foundation accepts no liability and offers no warranties in relation to the materials and documentation and their content.
7. If you wish to commercialise, license, sell, distribute, use or otherwise copy the materials and documents on this site other than as provided for in paragraphs 1 to 6 above, you must comply with the terms and conditions of the openEHR Free Commercial Use Licence, or enter into a separate written agreement with openEHR Foundation covering such activities. The terms and conditions of the openEHR Free Commercial Use Licence can be found at http://www.openehr.org/free_commercial_use.htm

Amendment Record

Issue	Details	Raiser	Completed
RELEASE 1.0			
5.0	<p>CR-00014. Adjust History.</p> <p>CR-000140. Redevelop Instruction, based on workflow principles.</p> <p>CR-000147: Make DIRECTORY Re-usable.</p> <p>CR-000162. Allow party identifiers when no demographic data. Changes to EHR, EVENT_CONTEXT, and ENTRY.</p> <p>CR-000164. Improve description of use of times in OBSERVATION.</p> <p>CR-000174. Add Admin Entry subtype.</p> <p>CR-000175. Make ENTRY.provider optional</p> <p>CR-000177. Make COMPOSITION.content a CONTENT_ITEM.</p> <p>CR-000180. Move EVENT_CONTEXT.composer to COMPOSITION</p> <p>CR-000181: Change ENTRY.provider to PARTY_PROXY.</p> <p>CR-000182: Rationalise VERSION.lifecycle_state and ATTESTATION.status.</p> <p>CR-000187: Correct modelling errors in DIRECTORY class and rename.</p> <p>CR-000188: Add <i>generating_type</i> function to ANY for use in invariants</p> <p>CR-000189. Add LOCATABLE.parent. New invariants in EHR and COMPOSITION.</p> <p>CR-000190. Rename VERSION_REPOSITORY to VERSIONED_OBJECT.</p> <p>CR-000191: Add EHR_STATUS class to EHR package.</p> <p>CR-000194: Correct anomalies with LOCATABLE.uid</p> <p>CR-000195: Rename EHR.all_compositions to compositions</p> <p>CR-000161. Support distributed versioning. Correct identifier types in EHR, ACTION classes.</p>	<p>S Heard</p> <p>S Heard</p> <p>T Beale</p> <p>T Beale</p> <p>S Heard</p> <p>T Beale</p> <p>S Heard</p> <p>H Frankel</p> <p>S Heard</p> <p>T Beale</p> <p>S Heard</p> <p>S Heard,</p> <p>D Kalra</p> <p>T Beale</p> <p>S Heard</p> <p>T Beale</p> <p>C Ma</p> <p>D Kalra</p> <p>T Beale</p> <p>T Beale</p> <p>S Heard</p> <p>T Beale</p> <p>T Beale</p> <p>H Frankel</p> <p>H Frankel</p> <p>T Beale</p> <p>S Heard</p> <p>T Beale</p> <p>H Frankel</p>	25 Jan 2006
RELEASE 0.96			
RELEASE 0.95			
4.5	<p>CR-000108. Minor changes to change_control package.</p> <p>CR-000024. Revert <i>meaning</i> to STRING and rename as <i>archetype_node_id</i>.</p> <p>CR-000098. EVENT_CONTEXT.time should allow optional end time.</p> <p>CR-000109. Add <i>act_status</i> to ENTRY, as in CEN prEN13606.</p> <p>CR-000116. Add PARTICIPATION.function vocabulary and invariant.</p> <p>CR-000118. Make package names lower case.</p> <p>CR-000064. Re-evaluate COMPOSITION.is_persistent attribute. Converted <i>is_persistent</i> to a function; added <i>category</i> attribute.</p> <p>CR-000102. Make DV_TEXT language and charset optional.</p>	<p>T Beale</p> <p>S Heard,</p> <p>T Beale</p> <p>S Heard,</p> <p>DSTC</p> <p>A Goodchild</p> <p>T Beale</p> <p>T Beale</p> <p>D Kalra</p> <p>DSTC</p>	10 Dec 2004
RELEASE 0.9			

Issue	Details	Raiser	Completed
4.4.1	CR-000096. Allow 0..* SECTIONS as COMPOSITION content.	DSTC	11 Mar 2004
4.4	CR-000019. Add HISTORY & STRUCTURE supertype. CR-000028. Change name of STRUCTURE class to avoid clashes. CR-000087. EVENT_CONTEXT. <i>location</i> should be optional. CR-000088. Move INSTRUCTION. <i>guideline_id</i> to ENTRY. CR-000092. Improve EVENT_CONTEXT <i>modelling</i> . Rename <i>author</i> to <i>composer</i> . Formally validated using ISE Eiffel 5.4.	T Beale H Frankel DSTC T Beale, D Kalra S Heard	06 Mar 2004
4.3.10	CR-000044. Add reverse ref from VERSION_REPOSITORY<T> to owner object. Add invariants to DIRECTORY and VERSIONED_COMPOSITION classes. CR-000046. Rename COORDINATED_TERM and DV_CODED_TEXT. <i>definition</i> .	D Lloyd T Beale	25 Feb 2004
4.3.9	CR-000021. Rename CLINICAL_CONTEXT. <i>practice_setting</i> to <i>setting</i> .	A Goodchild	10 Feb 2004
4.3.8	CR-000057. Environmental information needs to be included in the EHR.	T Beale	02 Nov 2003
4.3.7	CR-000048. Pre-release review of documents. CR-000049. Correct reference types in EHR, DIRECTORY classes. EHR. <i>contributions</i> , <i>all_compositions</i> , FOLDER. <i>compositions</i> attributes and invariants corrected. CR-000050. Update Path syntax reference model to ADL specification.	T Beale, D Lloyd	25 Oct 2003
4.3.6	CR-000041. Visually differentiate primitive types in openEHR documents.	D Lloyd	04 Oct 2003
4.3.5	CR-000013. Rename key classes, according to CEN ENV 13606.	S Heard, D Kalra, T Beale	15 Sep 2003
4.3.4	CR-000011. Add author attribute to EVENT_CONTEXT. CR-000027. Move <i>feeder_audit</i> to LOCATABLE to be compatible with CEN 13606 revision.	S Heard, D Kalra	20 Jun 2003
4.3.3	CR-000020. Move VERSION. <i>territory</i> to TRANSACTION. CR-000018. Add DIRECTORY class to RM.EHR Package. CR-000005. Rename CLINICAL_CONTEXT to EVENT_CONTEXT.	A Goodchild	10 Jun 2003
4.3.2	CR-000006. Make ENTRY. <i>provider</i> a PARTICIPATION. CR-000007. Replace ENTRY. <i>subject</i> and <i>subject_relationship</i> with RELATED_PARTY. CR-000008. Remove <i>confidence</i> and <i>is_exceptional</i> attributes from ENTRY. CR-000009. Merge ENTRY <i>protocol</i> and <i>reasoning</i> attributes.	S Heard, T Beale, D Kalra, D Lloyd	11 Apr 2003
4.3.1	DSTC review - typos corrected.	A Goodchild	08 Apr 2003

Issue	Details	Raiser	Completed
4.3	CR-000003, CR-000004. Removed ORGANISER_TREE. CLINICAL_CONTEXT and FEEDER_AUDIT inherit from LOCATABLE. Changes to path syntax. Improved definitions of ENTRY subtypes. Improved instance diagrams. DSTC detailed review. (Formally validated).	T Beale, Z Tun, A Goodchild	18 Mar 2003
4.2	Formally validated using ISE Eiffel 5.2. Moved VERSIONED_TRANSACTION class to EHR Package, to correspond better with serialised formalisms like XML.	T Beale, A Goodchild	25 Feb 2003
4.1	Changes post CEN WG meeting Rome Feb 2003. Moved TRANSACTION. <i>version_id</i> postcondition to an invariant. Moved <i>feeder_audit</i> back to TRANSACTION. Added ENTRY. <i>act_id</i> . VERSION_AUDIT. <i>attestations</i> moved to new ATTESTATIONS class attached to VERSIONED<T>.	T Beale, S Heard, D Kalra, D Lloyd	8 Feb 2003
4.0.2	Various corrections and DSTC change requests. Reverted OBSERVATION. <i>items</i> :LIST<HISTORY<T>> to <i>data</i> :HISTORY<T> and EVALUATION. <i>items</i> :LIST<STRUCTURE<T>> to <i>data</i> :STRUCTURE<T>. Changed CLINICAL_CONTEXT. <i>other_context</i> to a STRUCTURE. Added ENTRY. <i>other_participations</i> ; Added CLINICAL_CONTEXT. <i>participations</i> ; removed <i>hcp_legally_responsible</i> (to be archetyped). Replaced EVENT_TRANSACTION and PERSISTENT_TRANSACTION with TRANSACTION and a boolean attribute <i>is_persistent</i> .	T Beale	3 Feb 2003
4.0.1	Detailed corrections to diagrams and class text from DSTC.	Z Tun	8 Jan 2003
4.0	Moved HISTORY classes to Data Structures RM. No semantic changes.	T Beale	18 Dec 2002
3.8.2	Corrections on 3.8.1. No semantic changes.	D Lloyd	11 Nov 2002
3.8.1	Removed SUB_FOLDER class. Now folder structure can be nested separately archetyped folder structures, same as for ORGANISERs. Removed AUTHORED_TA and ACQUISITION_TA classes; simplified versioning.	T Beale, D Kalra, D Lloyd A Goodchild	28 Oct 2002
3.8	Added <i>practice_setting</i> attribute to CLINICAL_CONTEXT, inspired from HL7v3/ANSI CDA standard Release 2.0. Changed DV_PLAIN_TEXT to DV_TEXT. Removed <i>hca_coauthorising</i> ; renamed <i>hca_recording</i> ; adjusted all instances of *_ID; converted CLINICAL_CONTEXT. <i>start_time</i> , <i>end_time</i> to an interval.	T Beale, S Heard, D Kalra, M Darlison	22 Oct 2002
3.7	Removed Spatial package to Common RM document. Renamed ACTION back to ACTION_SPECIFICATION. Removed the class NAVIGABLE_STRUCTURE. Renamed SPATIAL to STRUCTURE. Removed classes STATE_HISTORY, STATE, SINGLE_STATE. Removed Communication (EHR_EXTRACT) section to ow document.	T Beale	22 Sep 2002
3.6	Removed Common and Demographic packages to their own documents.	T Beale	28 Aug 2002
3.5.1	Altered syntax of EXTERNAL_ID identifiers.	T Beale, Z Tun	20 Aug 2002

Issue	Details	Raiser	Completed
3.5	Rewrote Demographic and Ehr_extract packages.	T Beale	18 Aug 2002
3.3.1	Simplified EHR_EXTRACT model, numerous small changes from DSTC review.	T Beale, Z Tun	15 Aug 2002
3.3	Rewrite of contributions, version control semantics.	T Beale, D Lloyd, D Kalra, S Heard	1 Aug 2002
3.2	DSTC comments. Various minor errors/omissions. Changed inheritance of SINGLE_EVENT and SINGLE_STATE. Included STRUCTURE subtype methods from GEHR. <i>ehr_id</i> added to VT. Altered EHR/FOLDER attrs. Added EXTERNAL_ID. <i>version</i> .	T Beale, Z Tun	25 Jun 2002
3.1.1	Minor corrections.	T Beale	20 May 2002
3.1	Reworking of Structure section, Action class, Instruction class.	T Beale, S Heard	16 May 2002
3.0	Plans, actions updated.	T Beale, S Heard	10 May 2002
2.9	Additions from HL7v3 coded term model, alterations to quantity model, added explanation sections.	T Beale	5 May 2002
2.8.2a	Interim version with various review modifications	T Beale	28 Apr 2002
2.8.2	Error corrections to EHR_EXTRACT package. P Schloeffel comments on 2.7.	T Beale, P Schloeffel	25 Apr 2002
2.8.1	Further minor changes from UCL on v2.7.	T Beale	24 Apr 2002
2.8	Dipak Kalra (UCL) comments on v2.6 incorporated. Added External Package. Minor changes elsewhere.	T Beale, D Kalra	23 Apr 2002
2.7	Final development of initial draft, including EHR_EXTRACT, related models	T Beale	20 Apr 2002
2.6	Further development of path syntax, incorporation of Dipak Kalra's comments	T Beale, D Kalra	15 Apr 2002
2.5	Further development of clinical and record management clusters.	T Beale	10 Apr 2002
2.4	Included David Lloyd's rev 2.3 comments.	T Beale, D Lloyd	4 Apr 2002
2.3	Improved context analysis.	T Beale	4 Mar 2002
2.2	Added path syntax.	T Beale	19 Nov 2001
2.1	Minor organisational changes, some content additions.	T Beale	18 Nov 2001
2.0	Rewrite of large sections post-Eurorec 2001 conference, Aix-en-Provence. Added folder, contribution concepts.	T Beale	15 Nov 2001
1.2	Major additions to introduction, design philosophy	T Beale	1 Nov 2001
1.1	Major changes to diagrams; STILL UNREVIEWED	T Beale	13 Oct 2001

Issue	Details	Raiser	Completed
1.0	Based on GEHR Object Model	T Beale	22 Sep 2001

Acknowledgements

Thanks to...

The work reported in this paper has been funded in by a number of organisations, including University College, London; The Cooperative Research Centres Program through the Department of the Prime Minister and Cabinet of the Commonwealth Government of Australia; Ocean Informatics, Australia.

Andrew Goodchild, senior research scientist at the Distributed Systems Technology Centre, Brisbane provided valuable in-depth comments and insights on all aspects of the model during its early development.

CORBA is a trademark of the Object Management Group

.Net is a trademark of Microsoft Corporation

1	Introduction.....	12
1.1	Purpose.....	12
1.2	Related Documents	12
1.3	Status.....	12
1.4	Peer review	12
1.5	Conformance.....	13
2	Background	14
2.1	Requirements	14
2.1.1	Original GEHR Requirements.....	14
2.1.2	GEHR Australia Requirements.....	14
2.1.3	European Synapses and SynEx Project Requirements	14
2.1.4	European EHCR Support Action Requirements.....	15
2.1.5	ISO EHR Requirements.....	15
2.1.6	openEHR Requirements	15
2.2	Design Principles	15
2.2.1	The System-of-systems EHR Context.....	16
2.2.2	Context Model of Recording	16
2.3	Relationship to other Health Information Models	17
2.3.1	CEN TC/251 prEN13606	17
2.3.2	HL7 Version 3.....	18
2.3.3	OMG HDTF.....	18
3	The EHR Information Model	19
3.1	Overview.....	19
4	The EHR	21
4.1	Overview.....	21
4.2	Design Principles	21
4.2.1	Compositions	21
4.2.2	Folders	23
4.2.3	EHR Status.....	24
4.2.4	Change Control of the EHR.....	25
4.2.5	Versioning of Compositions	26
4.2.6	Versioning Scenarios	27
5	EHR Package.....	29
5.1	Overview.....	29
5.2	EHR Creation Semantics	30
5.3	Time in the EHR	30
5.4	Historical Views of the Record.....	31
5.5	Class Descriptions.....	31
5.5.1	EHR Class.....	31
5.5.2	VERSIONED_EHR_STATUS Class.....	32
5.5.3	EHR_STATUS Class	33
5.5.4	VERSIONED_COMPOSITION Class.....	33
6	Composition Package	35
6.1	Overview.....	35
6.2	Design Principles	35
6.2.1	Composition Composer	35

6.2.2	Event Context.....	36
6.2.3	Composition Content.....	38
6.3	Path Semantics.....	39
6.4	Class Descriptions	39
6.4.1	COMPOSITION Class	39
6.4.2	EVENT_CONTEXT Class	40
7	Content Package	43
7.1	Overview	43
7.2	Class Descriptions	43
7.2.1	CONTENT_ITEM Class.....	43
8	Navigation Package.....	44
8.1	Overview	44
8.2	Class Descriptions	45
8.2.1	SECTION Class	45
8.3	Section Instance Structures.....	46
8.3.1	Problem/SOAP Headings.....	46
9	Entry Package	48
9.1	Design Principles.....	48
9.1.1	Information Typology	48
9.1.2	Clinical Statement Status.....	49
9.2	Entry and its Subtypes.....	50
9.2.1	The Entry class.....	52
9.2.2	Care_entry and Admin_entry	53
9.2.3	Observation	53
9.2.4	Evaluation.....	56
9.2.5	Instruction and Action.....	57
9.3	Class Descriptions	66
9.3.1	ENTRY Class	66
9.3.2	ADMIN_ENTRY Class.....	67
9.3.3	CARE_ENTRY Class	68
9.3.4	OBSERVATION Class	68
9.3.5	EVALUATION Class	69
9.3.6	INSTRUCTION Class.....	70
9.3.7	ACTIVITY Class	70
9.3.8	ACTION Class	71
9.3.9	INSTRUCTION_DETAILS Class	71
9.3.10	ISM_TRANSITION Class	72
9.4	Instance Structures.....	73
9.4.1	OBSERVATION	73
9.4.2	EVALUATION.....	74
9.4.3	INSTRUCTION	76
A	Glossary	78
A.1	openEHR Terms	78
A.2	Clinical Terms	78
A.3	IT Terms	78
B	References.....	79

B.1	General.....	79
B.2	European Projects	80
B.3	CEN	80
B.4	GEHR Australia	81
B.5	HL7v3	81
B.6	OMG	81
B.7	Software Engineering	81
B.8	Resources	82

1 Introduction

1.1 Purpose

This document describes the *openEHR* EHR Information Model, which is a model of an interoperable EHR in the ISO RM/ODP information viewpoint. This model defines a logical EHR information architecture rather than just an architecture for communication of EHR extracts or documents between EHR systems. The openEHR definition of the EHR Extract is given in the *openEHR EHR_EXTRACT* Information Model.

The intended audience includes:

- Standards bodies producing health informatics standards
- Software development groups using *openEHR*
- Academic groups using *openEHR*
- The open source healthcare community

1.2 Related Documents

Prerequisite documents for reading this document include:

- The *openEHR* Modelling Guide
- The *openEHR* Support Information Model
- The *openEHR* Data Types Information Model
- The *openEHR* Common Information Model

Other documents describing related models, include:

- The *openEHR EHR_EXTRACT* Information Model
- The *openEHR* Demographic Information Model

1.3 Status

This document is under development, and is published as a proposal for input to standards processes and implementation works.

This document is available at http://svn.openehr.org/specification/TAGS/Release-1.0/publishing/architecture/rm/ehr_im.pdf.

The latest version of this document can be found at http://svn.openehr.org/specification/TRUNK/publishing/architecture/rm/ehr_im.pdf.

Blue text indicates sections under active development.

1.4 Peer review

Areas where more analysis or explanation is required are indicated with “to be continued” paragraphs like the following:

To Be Continued: more work required

Reviewers are encouraged to comment on and/or advise on these paragraphs as well as the main content. Please send requests for information to info@openEHR.org. Feedback should preferably be provided on the mailing list openehr-technical@openehr.org, or by private email.

1.5 Conformance

Conformance of a data or software artifact to an *openEHR* Reference Model specification is determined by a formal test of that artifact against the relevant *openEHR* Implementation Technology Specification(s) (ITSs), such as an IDL interface or an XML-schema. Since ITSs are formal, automated derivations from the Reference Model, ITS conformance indicates RM conformance.

2 Background

This section describes the inputs to the modelling process that created the *openEHR* Information Model.

2.1 Requirements

There are broadly three sets of requirements which inform this model, as described in the following subsections.

2.1.1 Original GEHR Requirements

From the European GEHR project (1992-5; [19]), the following broad requirements areas were identified:

- the life-long EHR;
- priority: Clinician / Patient interaction;
- medico-legal faithfulness, traceability, audit-trailing;
- technology & data format independent;
- facilitate sharing of EHRs;
- suitable for both primary & acute care;
- secondary uses: education, research, population medicine;
- open standard & software deliverables;

The original deliverables can be reviewed in detail at the [GEHR page at CHIME, UCL](#).

2.1.2 GEHR Australia Requirements

The GEHR Australia project (1997-2001; [32], [33]) introduced further requirements, including:

- support for clinical data structures: lists, tables, time-series etc;
- safer information model than the original (European) GEHR: context attributes only in valid places (but still similar style);
- separate groups for “persistent”, “demographic” and “event” information in EHR, which corresponds closely to real clinical querying patterns;
- introduction of formally specified archetypes, and archetype-enabled information model;
- interoperability at the knowledge level, i.e. level of domain definitions of information such as “discharge summary” and “biochemistry result”;
- XML-enabled;
- consider compatibility with CEN 13606, Corbamed, HL7v3.

GEHR Australia produced a proof of concept implementation in which clinical archetypes were developed and used. See [3] for a technical description of archetypes.

2.1.3 European Synapses and SynEx Project Requirements

Following the original Good European Health Record project the EU-funded Synapses (1996-8; [25]) and SynEx (1998-2000; [14]) projects extended the original requirements basis of GEHR to include further requirements, as follows:

- the requirements of a federation approach to unifying disparate clinical databases and EPR systems: the federated health record (FHR) [26];

- the need to separate a generic and domain independent high-level model for the federated health record from the (closely related) model of the meta-data which defines the domain specific health record characteristics of any given clinical specialty and any given federation of database schemata;
- a formalism to define and communicate (share) knowledge about the semantic hierarchical organisation of an FHR, the permitted data values associated with each leaf node in a record hierarchy and any constraints on values that leaf nodes may take (the Synapses Object Dictionary) [27];
- the core technical requirements of and interfaces for a federation middleware service [25].

2.1.4 European EHCR Support Action Requirements

This EU Support Action project (“SupA”; [17], [18], [20]) consolidated the requirements published by a wide range of European projects and national health informatics organisations as a Consolidated List of Requirements [16].

2.1.5 ISO EHR Requirements

The above requirements publications and the recent experience of *openEHR* feed into the definition of a set of EHR requirements authored by ISO Technical Committee 215 (Health Informatics) - ISO TS 18308. The present draft [13] has been reviewed by the authors of this document and *openEHR* will seek to maintain a close mapping between its information models and services and this international requirements work. The *openEHR* mapping to ISO 18308 can be found on the *openEHR* website.

2.1.6 *openEHR* Requirements

New requirements generated during the development of *openEHR* included the following:

- major improvements in information models from the point of view of reducing programmer errors and ambiguity;
- better modelling of time and context (temporal/spatial approach);
- better understanding of legacy system / federation problem;
- workflow modelling;
- harmonise with CEN EN 13606;
- integration with HL7v2 and other messaging systems;
- numerous specific clinical requirements.

2.2 Design Principles

There are various considerations outside the requirements which influence the EHR information model, some of which are described by Beale & Heard, e.g. [4], [5], [6]. These are summarised as follows:

- system-of-systems understanding of information infrastructures (i.e. a set of collaborating middleware components and services), described in more detail below;
- ontological framework within which reference models and archetypes fit;
- design paradigm: two level modelling, archetypes;
- separation of models according to responsibilities;

- a “context model” of information acquisition which describes contexts for each information fragment from the most detailed information structures to the context of the clinical session, and the enterprise (described in further detail below);
- the principle of relegating the vagaries of implementation technologies to separate specifications, rather than compromising the central model in any way.

2.2.1 The System-of-systems EHR Context

Health care information systems, both at the level of a single enterprise and regional healthcare networks, will increasingly comprise a set of software components collaborating through middleware and web services, enabling distributed operations and data exchange. This “system-of-systems” view embraces the distributed object paradigm (exemplified by CORBA and .Net), the message-based paradigm (exemplified by HL7), and in a less formal sense, most of today’s organically evolved multi-database hospital IT environments. The distributed systems paradigm is also the generally accepted theoretical and standards view, as exemplified by any modern textbook on information processing, by the ISO RM/ODP standard, by health informatics standards such as OMG’s Corbamed [37], [38], [39] specifications and CEN family of health information standards ([28] and many others), and by a wide range of international projects, national health information strategies and demonstrator pilots.

Accordingly, the EHR is understood in *openEHR* as one system (or service) within a distributed health information infrastructure, whose purpose is to manage the longitudinal and comprehensive EHR of individual patients. There is no definitive list of services or systems required within a health care environment. However, it is generally understood that in any deployment scenario an EHR service would be complemented by a range of other services including: terminology, clinical reference data (prescribing, interactions), order management, scheduling, decision support, demographics (both patient and health provider), pathology, imaging, and access control. In a distributed system infrastructure, each of these will usually exist as a service within an infrastructure node. Each system has its own information model, describing the semantics of the data which can be obtained from it or written to it, as well as its service interface describing the functional interface to the system.

The approach taken in defining the *openEHR* EHR Information Model has been to assume this distributed deployment environment, and therefore the existence of several other services, at minimum for demographics, access control, terminology and archetypes. The Information Model therefore contains classes and attributes to facilitate interoperability with such services rather than their duplication inside the EHR service.

However, all service-level information models in *openEHR* - that is to say, the information models of the EHR, demographics etc - share the same platform of support information models, consisting of Support IM, Data structures IM, Data types IM, and Common IM.

2.2.2 Context Model of Recording

The *openEHR* EHR model takes account of a systematic analysis of “context”, described in [5]. Contexts in the real world are mapped to particular levels of the information model in a clear way, according to the scheme shown in FIGURE 1. On the left hand side is depicted the context of a data-entry session in which the information generated by a “healthcare event”, containing “clinical statements”, is added to the EHR. A healthcare event is defined as any business activity of the health care system for the patient, including encounters, pathology tests, and interventions. A clinical statement is the minimal indivisible unit of information the clinician wants to record. Clinical statements are shown in the diagram as having temporal and spatial structure as well as data values. Each of these three contexts has its own audit information, consisting of who, when, where, why information.

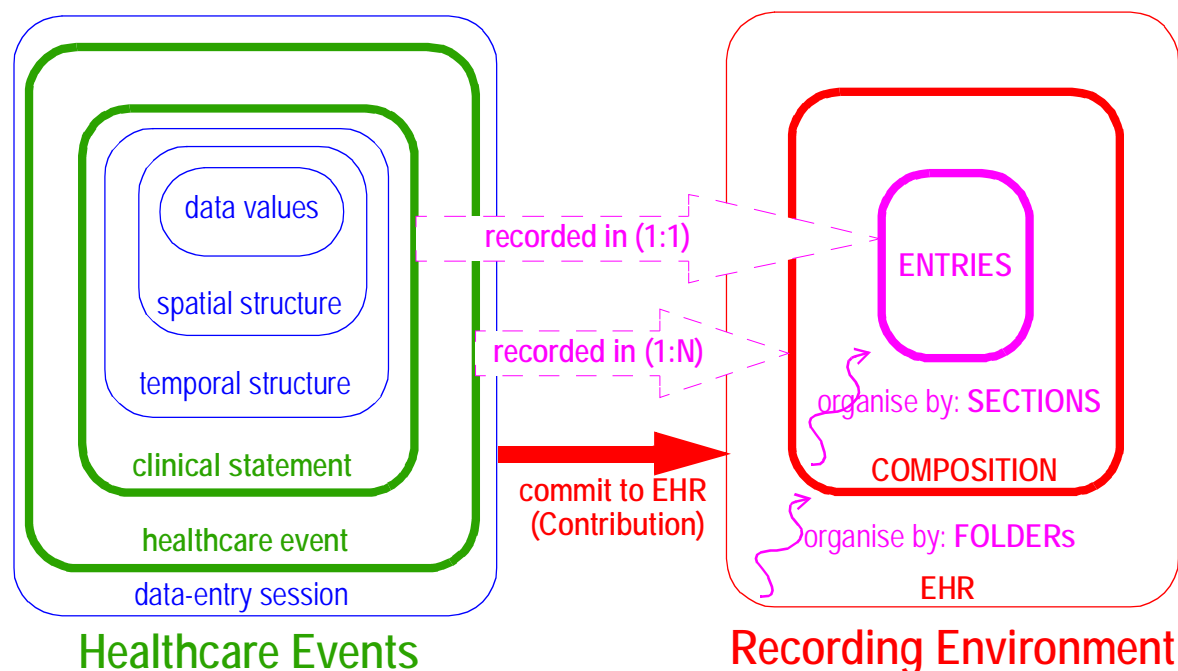

FIGURE 1 General Model of Recording

On the right hand side of FIGURE 1, the EHR recording environment is represented. The EHR consists of distinct, coarse-grained items known as Compositions added over time and organised by Folders. Each Composition consists of Entries, organised by Sections within the Composition. The audit information for each context is recorded at the corresponding level of the EHR.

2.3 Relationship to other Health Information Models

Where relevant, the correspondences to other information models have been documented in this specification. Correspondences to the GEHR Australia and EU Synapses/SynEx models are shown, since these are the models on which the *openEHR* EHR information model is primarily based. The following sections summarise the other models and standards with which correspondences are shown.

2.3.1 CEN TC/251 prEN13606

These models have been influenced by and have also influenced the models in CEN prEN13606 (2005 revision); accordingly, relationships to 13606 have been documented fairly precisely.

Since January 2002, the prEN13606 prestandard has been the subject of significant revision, as part of its transition to a full European Standard (“EN”). This work has been influenced by the *openEHR* specifications, and has itself been a source of further insights and changes to the *openEHR* specifications. Particular areas of *openEHR* which have been changed due to this process include:

- change of major class names (TRANSACTION -> COMPOSITION etc; see CR-000013);
- improved model of ATTESTATION (see CR-000025);
- improved model of feeder audits (see CR-000027).

Implementation experience with Release 0.9 and 0.95 of *openEHR* has further improved these areas significantly. Nevertheless, *openEHR* is not a copy of CEN, for two reasons. Firstly, its scope includes systems, while EN13606 defines an EHR Extract; secondly, EN13606 suffers somewhat from “design by committee”, and has no formal validation mechanism for its models.

2.3.2 HL7 Version 3

Correspondences to some parts of HL7 version 3 (ballot 5, July 2003) are also documented where possible, however, it should be understood that there are a number of difficulties with this. Firstly, while the HL7v3 Reference Information Model (RIM) - the closest HL7 artifact to an information model - provides similar data types and some related semantics, it is not intended to be a model of the EHR. In fact, it differs from the information model presented here (and for that matter most published information models) in two basic respects: a) it is an amalgam of semantics from many systems which would exist in a distributed health information environment, rather than a model of just one (the EHR); b) it is also not a model of data, but an “analysis pattern” in the sense of Fowler [43] from which further specific models - subschemas - are developed by a custom process of “refinement by restriction”, in order to arrive at message definitions. As a consequence, data in messages are not instances of HL7v3 RIM classes, as would be the case in other systems based on information models of the kind presented here.

Despite the differences, there are some areas that appear to be candidates for fairly direct mapping, specifically the data types and terminology use, and the correspondence between *openEHR* Compositions and some parts of the HL7 Clinical Document Architecture (CDA).

2.3.3 OMG HDTF

In general, the *openEHR* information models represent a more recent analysis of the required semantics of EHR and related information than can be found in the information viewpoint of the OMG HDTF specifications (particularly PIDS and COAS). However, the computational viewpoint (i.e. functional service interface definitions) is one of the inputs to the *openEHR* service model development activity.

3 The EHR Information Model

3.1 Overview

FIGURE 2 illustrates the package structure of the *openEHR* EHR information model.

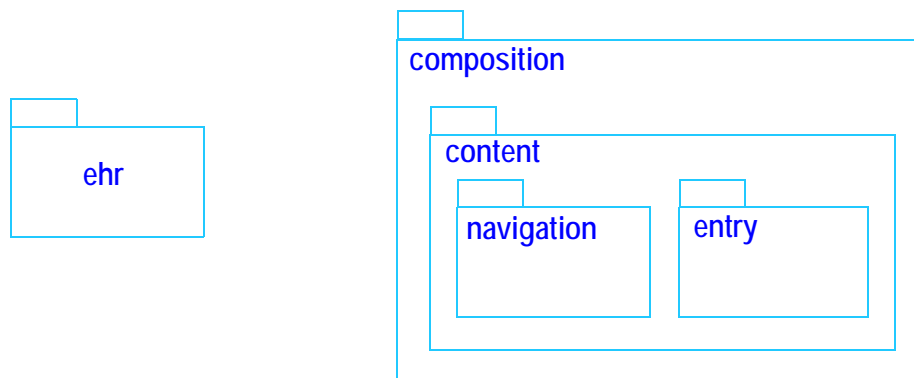

FIGURE 2 ehr Package Structure

The packages are as follows:

ehr: This package contains the top level structure, the EHR, which consists of an EHR_STATUS object, a hierarchical directory of FOLDERS, containing references to VERSIONED_COMPOSITIONS, and a collection of CONTRIBUTIONS which document the changes to the EHR over time.

composition: The Composition is the EHR's top level "data container", and is described by the COMPOSITION class.

content: This package contains the Navigation and Entry packages, whose classes describe the structure and semantics of the contents of Compositions in the health record.

navigation: The SECTION class provides a navigational structure to the record, similar to "headings" in the paper record. ENTRIES and other SECTIONS can appear under SECTIONS.

entry: This package contains the generic structures for recording clinical statements. Entry types include ADMIN_ENTRY, OBSERVATION (for all observed phenomena, including mechanically or manually measured, and responses in interview), EVALUATION (for assessments, diagnoses, plans), INSTRUCTION (actionable statements such as medication orders, recalls, monitoring, reviews), and ACTION (information recorded as a result of performing Instructions).

FIGURE 3 illustrates an overview of the class structure of the EHR Information Model, along with the main concepts on which they rely, namely Data Types, Data Structures, Archetyped, and Identification.

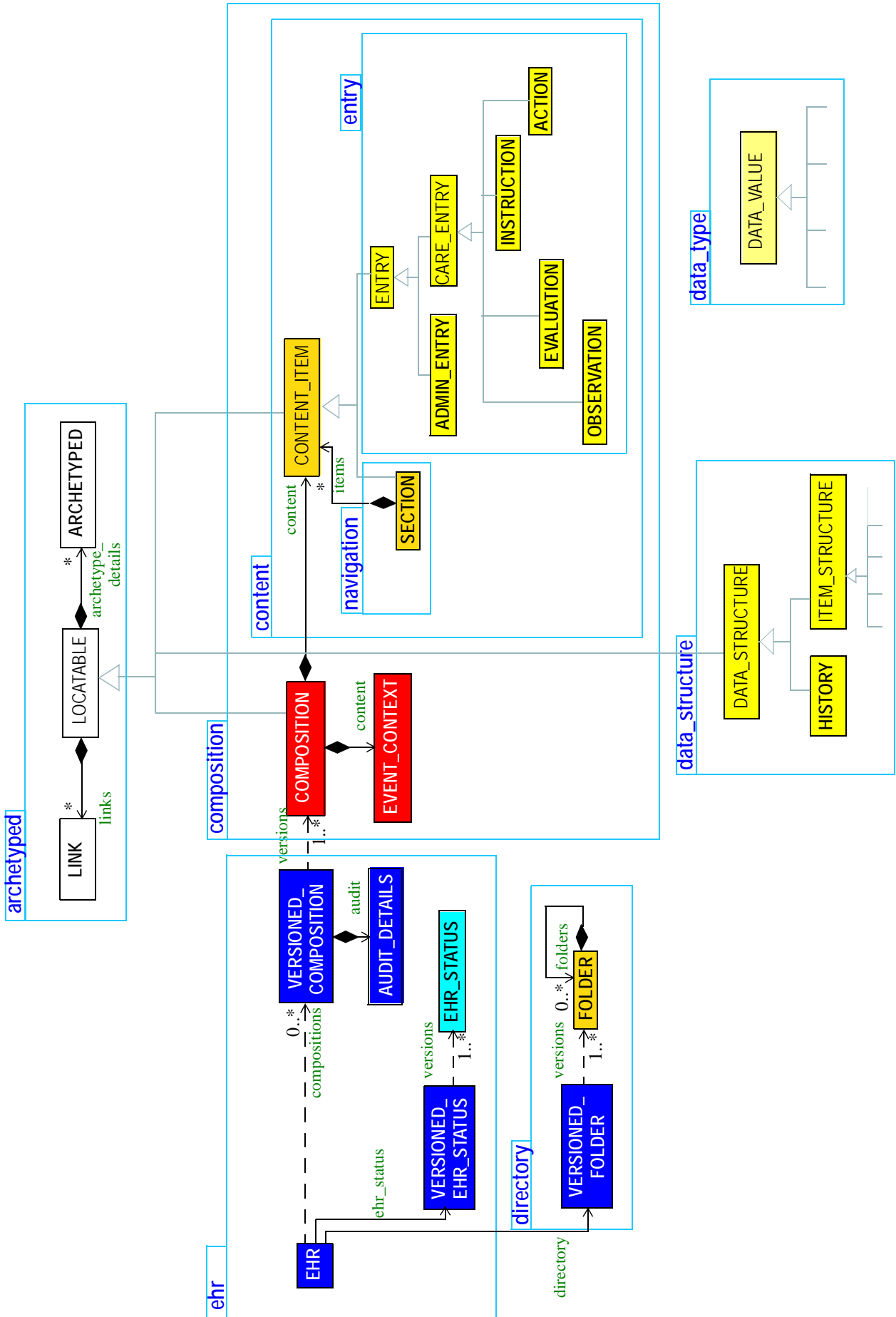

FIGURE 3 openEHR and EHR Extract Information Model Overview

4 The EHR

4.1 Overview

The design of the *openEHR* EHR is based on concepts and experience from the GeHR Australia project [32], the Synapses project [25], [26], [27], the CEN prEN13606 standard (2005), and the HL7 Clinical Document Architecture (CDA) Release 1 [35]. The contents of an *openEHR* EHR consist of an EHR status object, Composition objects (equivalent to the CEN 13606 Composition and the HL7 CDA Document), and an optional directory of Folders (a CEN 13606 concept). All content in the EHR is versioned, by means of the `VERSIONED_OBJECT<T>` type (defined in the Common IM). This means that every previous state of the EHR - i.e. all states of the EHR status, the Compositions and the directory structure - is available. The semantics of versioning are provided by the concepts defined in the `rm.common.change_control` package. All changes to the EHR are made by committing Contributions (a similar idea to “change-sets” in configuration management (CM) systems), where a Contribution can include changes to the EHR status objects, creation, update or correction of Compositions, creation or modification of the Folder structure, move of Compositions in the Folder structure, and deletion of Compositions or part of the Folder structure. The use of Contributions guarantees that the EHR progresses from one valid state to another, regardless of what changes occur in any particular contribution.

The discussion below commences by describing the general organisation of the EHR, and then how change control applies to the EHR. It then describes the semantics of Compositions - the containers of data in the EHR, and finally describes the role of the Folder structure.

4.2 Design Principles

4.2.1 Compositions

The Composition concept in the *openEHR* EHR originated from the Transaction concept of the GEHR project [21], [22], [23], [24], which was based on the concept of a unit of information corresponding to the interaction of a healthcare agent with the EHR. It was originally designed to satisfy the following needs (which include the well-known ACID characteristics of transactions [8]):

- *durability*: the need for a persistent unit of information committal in the record;
- *atomicity*: the need for a minimal unit of integrity for clinical information, corresponding to a minimal unit for committal, transmission and security;
- *consistency*: the need for contributions to the record to leave the record in a consistent state;
- *isolation*: the need for contributions to the record by simultaneous users not to interfere with each other;
- *indelibility*: the requirement that information committed to the record be indelible in order to support later investigations, for both medico-legal and process improvement purposes, and the consequent requirement to be able to access previous states of the record;
- *modification*: the need for users to be able to modify EHR contents, in order to correct errors or update previously recorded information (e.g. current medications, family history); and
- *traceability*: the need to record adequate auditing information at committal, in order to provide clinical and legal traceability.

The Transaction concept has since been renamed to “Composition”, which is the name of the equivalent concept in the current CEN EN13606, and it has been expanded and more formally defined in

openEHR in two ways. Firstly, the idea of a unit of committal has been formalised by the *openEHR* model of change control (see the *openEHR* Common Information Model); how this applies to the EHR and compositions is described below. Secondly, the informational purpose of a Composition is no longer just to contain data from a passing clinical event such as a patient contact, but also to capture particular categories of clinical data which have long-lived significance, such as problem and medication lists.

Experience with health information systems, including the GEHR (Australia) project, SynEx, Synapses, and inspection of common commercial systems, has shown that there are two general categories of information at the coarse level which exist in the EHR: *event* items, and longitudinal, or *persistent* items, of which there might be various kinds.

Event Compositions

Events record what happens during the *clinical session* context [5] which occur due to billable health-care system events with or for the patient, such as patient contacts, but also sessions in which the patient is not a participant (e.g. surgery) or not present (e.g. pathology testing). Persistent items capture information which remains valid in the long term, such as the patient's family history, current medications, care plan and so on. Both types of information are contained within Compositions. FIGURE 4 illustrates a simple EHR comprising an accumulation of event Compositions.

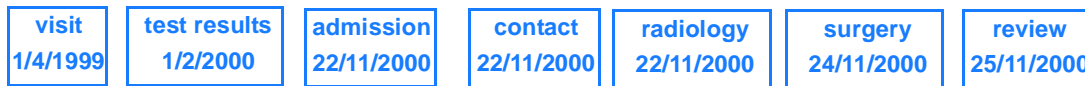

FIGURE 4 Basic Event-oriented EHR

An important job of the event Composition is to record not only the data from the healthcare event, such as observations on the patient, but also to record the event context information, i.e. the who, when, where and why of the event. For this reason, a specific class representing clinical context is associated with event compositions in the formal model.

Persistent Compositions

However, in a more sophisticated EHR, there are also likely to be persistent compositions. Many items of long-term interest in the record are separated by clinicians into well-known categories, such as:

- Family history
- Social history
- Problem list
- Current medications
- Therapeutic precautions
- Vaccination history
- Lifestyle
- Care plan

Note that over time, the number of event Compositions is likely to far outstrip the number of persistent Compositions. FIGURE 5 illustrates an EHR containing persistent information as well as event information.

In any clinical session, an event composition will be created, and in many cases, persistent compositions will be modified. How this works is described below under Change Control of the EHR on page 25.



FIGURE 5 An EHR containing Event and Persistent Compositions

4.2.2 Folders

As Compositions accumulate over time in the EHR, they form a long-term patient history. Previous work in CEN [28] - [31] and SynEx [26] suggests that it is useful to be able to organise Compositions using a hierarchy of folders to classify them, much the same way files in a file system are arranged in the directory structure, as visualised by the Windows Explorer and other similar tools. In the *openEHR* model, folders do not contain Compositions by value but by reference, and are completely optional. More than one Folder can refer to the same Composition. Folders might be used to manage a simple classification of Compositions, e.g into event and persistent, or they might be used to create numerous categories, based on episodes or other groupings of Compositions. Folder structures can be archetyped.

A simple structure showing Folders referencing Compositions is shown in FIGURE 6, in which the following folders are used:

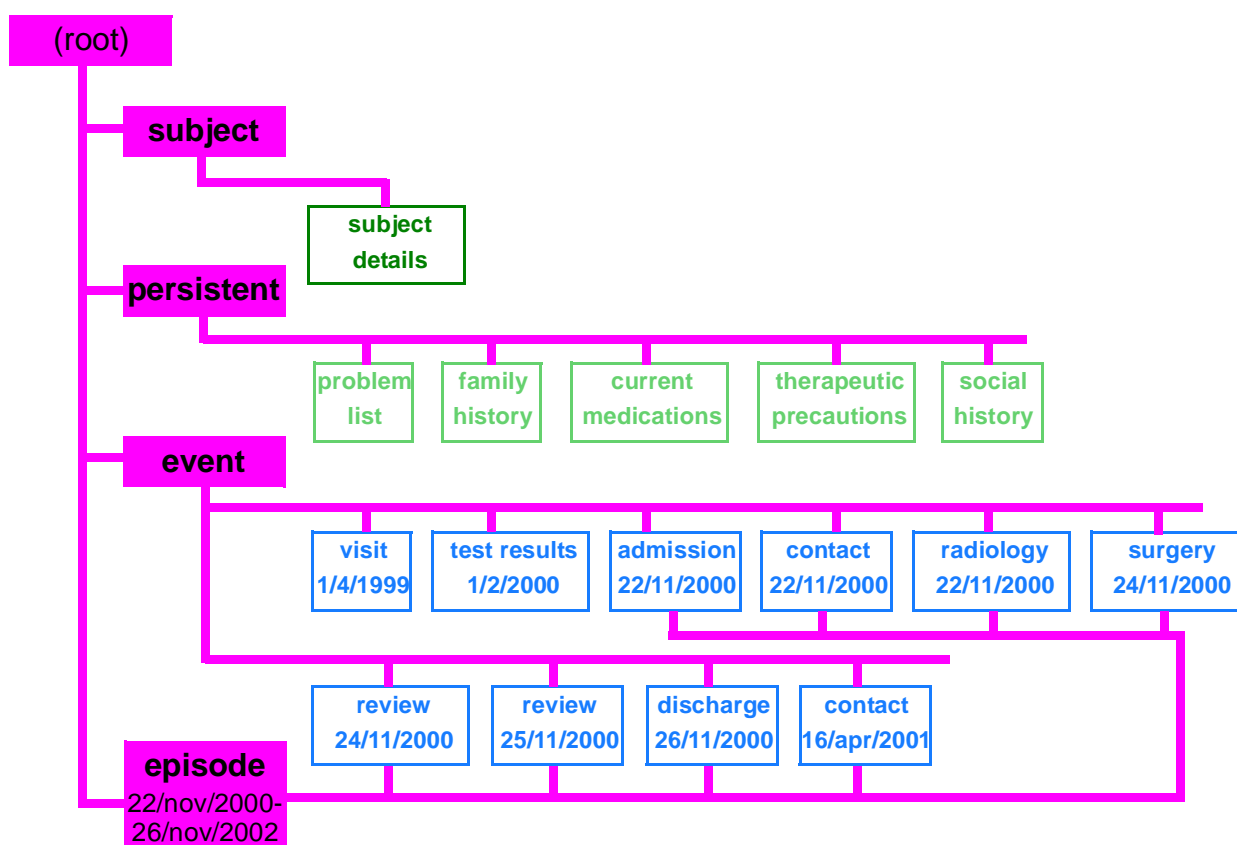

FIGURE 6 Using Folders to Group Compositions

Subject: a composition containing clinically relevant demographic data of the patient;

Persistent: compositions containing information which is valid in the long term;

Event: compositions containing information whose currency is limited to the short term after the time of committal;

Episode_xxx: rather than using a single ‘event’ folder, it may be convenient to group event compositions into episodes (periods of treatment at a health care facility relating to one or more identified problems) and/or other categories such as on the basis of type of healthcare (orthodox, homeopathic, etc).

A justification for these particular categories is based on patterns of access. The persistent category consists of a dozen or so compositions described above, and which are continually required by querying (particularly lifestyle, current problems and medications). The event category consists of clinical data whose relevancy fades fairly quickly, including most measurements made on the patients or in pathology. Compositions in this category are thus potentially very numerous over the patient’s lifetime, but of decreasing relevance to the clinical care of the patient in time; it therefore makes sense to separate them from the persistent compositions.

Regardless of the folder structure used, the folder concept in itself poses no restrictions, nor does it add any clinical meaning to the record - it simply provides a logical navigational structure to the “lumps” of information committed to the record (remembering that inside compositions, there are other means of providing fine-grained structure in entries).

Note that neither the folder names nor the composition names described and illustrated above are part of the *openEHR* EHR architecture: all such details are provided by archetypes; hence, EHR structures based on completely different conceptions of division of information, or even different types of medicine are equally possible.

The folder structure of an EHR constitutes a third category of information that must be controlled over time, in order to allow changes to the folder structure to be remembered along with changes to content. The contents of a typical EHR now resemble FIGURE 7.



FIGURE 7 An EHR containing Compositions and Folder Structure CIs

4.2.3 EHR Status

A final category of information which may be needed in the change-controlled EHR is that of “EHR status information”, including status flags on the EHR to indicate whether it is actively in use, inactive, and so on. An EHR Status object is used to record such flags. Other EHR-wide meta-data may be recorded in the archetyped part of this object, including environment settings, software application names and version ids, identification and versions of data resources such as terminologies and possibly even actual software tools, configuration files, keys and so on. Such information is commonly versioned in software configuration management systems, in order to enable the reconstruction of earlier versions of software with the correct tools. One reason to store such information at all is that it adds to medico-legal support when clinicians have to justify a seemingly bad decision: if it can be shown that the version of software in use at the time was faulty, they are protected, but to do this requires that such information be recorded in the first place. We therefore add a fourth category of content to the notional controlled EHR - that of “EHR status”, as shown in FIGURE 8.



FIGURE 8 A Comprehensive Medico-legal EHR

4.2.4 Change Control of the EHR

The EHR described thus far is essentially an EHR status object plus a logical arrangement of Compositions within a directory structure of Folders. However we have not described the semantics of update to the record, or audit-trailing of changes.

A number of requirements and design considerations lead to the final design of Compositions in the *openEHR* EHR. The first is the *system interaction context*, in which a healthcare agent (usually a human, but may be a software process) interacts with the EHR system to enter data. This is the context during which Compositions and Folder structures are created or modified on the system, and, the contextual details of who, when and where must be recorded. As described in [5], these details will be different from the context details of the healthcare event, as is the case when the EHR is updated some time after a contact, and by other personnel.

Given an EHR in which there is a folder structure, and event and persistent Compositions, the general model of update of the EHR is that any of these might be created and/or modified during the update. The simplest, most common case is probably the creation of a single contact Composition, which is placed in an “events” folder. Another common case will be the creation of an event Composition, and modification of one or more persistent Compositions, e.g. due to facts learned in the consultation about family history, or due to prescription of new medications. Other types of updates include corrections to existing Compositions, and acquisition of compositions from another site such as a hospital. Any of these updates might also include a change to the folder structure, or the moving of existing Compositions to other Folders. Naturally these scenarios depend on a structure of the record including event and persistent compositions, and a folder structure; in the extreme, an EHR consisting only of event Compositions and no folders will experience only the creation of a single Composition for most updates, with acquisitions being the exception.

Recording of contextual information is not the only requirement of the EHR. Numerous projects (GEHR/Europe, GEHR/Australia, SynEx, Synapses etc) as well as standards (CEN 13606, the emerging ISO 18308 EHRRA Requirements) and academic work all agree on the need to satisfy a number of medico-legal requirements of the EHR. These are as follows: that all additions and changes to the record be audit-trailed and that all previous states of the record be available for the purposes of medico-legal investigation. The former is satisfied by the recording of context details in the relevant places (including at the Entry level, dealt with later in this specification). The latter requirement leads to the use of version control of information items, and eventually, to a formal change management approach.

Change management of information is a non-trivial business, and requires a well-defined approach, such as the “configuration management” (CM) paradigm described in the *openEHR* Common Information Model. Under this paradigm we can visualise how changes occur to the EHR. FIGURE 9 shows a number of Contributions to the EHR as follows:

- The first is due to a patient contact, and causes the creation of a new contact composition; it also causes changes to the problem list, current medications and care plan compositions (once again, in a differently designed record, all this information might have been contained in a single event Composition; likewise, it might be been distributed into even more Compositions).
- The next Contribution is the acquisition of test results from a pathology laboratory.
- The third is another contact in which both family history and the folder structure are modified.
- This fourth is an error correction (e.g. a misspelled name, wrongly entered value), and shows that there can be a Contribution even when there is no healthcare event.

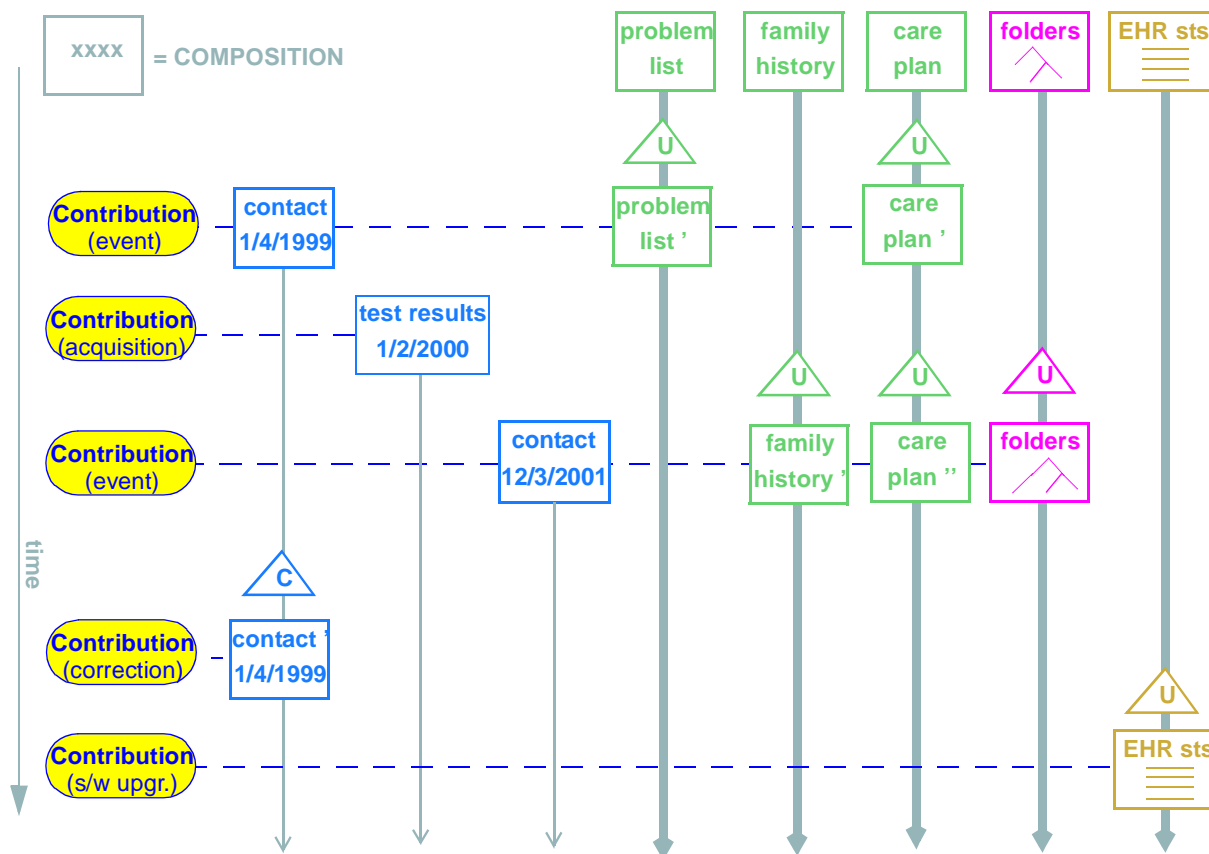

FIGURE 9 Contributions to the EHR

- The last is an update to the EHR status information in the EHR, due to a software upgrade.

We can now see that the configuration management paradigm is a suitable approach. Consider the EHR described thus far:

- it is a repository of information about the patient, which is separated into distinct entities, (Compositions);
- it may have a directory of Folders acting as a navigational structure of the compositions;
- there can be multiple, simultaneous users of the repository;
- changes to the information occur due to interactions of multiple users with the repository, and must be attested with revision history information;
- previous states in time of the repository must be available upon request.

Thus, the EHR corresponds very closely to the general model of a change-controlled repository. The implication is that we should consider contributions to the EHR to be the change sets described in the CM paradigm, where each contribution causes the creation or modification of one or more Compositions (configuration items, or “CIs”) and/or changes to the directory structure and status information.

4.2.5 Versioning of Compositions

Versioning of Compositions is achieved with the `VERSIONED_OBJECT<T>` type from the `change_control` package (Common IM), which in the `composition` package is explicitly bound to the `COMPOSITION` class, via the class `VERSIONED_COMPOSITION` which inherits from the type `VERSIONED<COMPOSITION>`.

The effect of version control on Compositions is visualised in FIGURE 10. The versions (each “version” being a COMPOSITION) shown here in a VERSIONED_COMPOSITION are the same versions shown along each vertical line in FIGURE 9, this time shown with their associated audit items. The set of versions should be understood as a set of successive modifications of the same data in time.

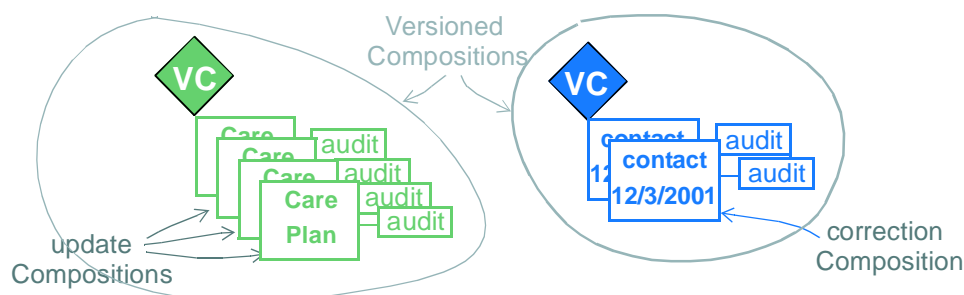

FIGURE 10 The versioned composition

The VERSIONED_COMPOSITION can be thought of as a kind of smart repository: how it stores successive versions in time is an implementation concern (there are a number of intelligent algorithms available for this sort of thing), but what is important is that its functional interface enables any version to be retrieved, whether it be the latest, the first, or any in between.

Returning to Compositions, the logical types “event Composition” and “persistent Composition” are modelled using the class COMPOSITION, a coded attribute *category*, and a Boolean-returning function *is_persistent*. The function returns true for those categories deemed to be persistent categories, and can be implemented as required on each system. For event Compositions this function should return false. There will usually be a *context* attribute, which carries the clinical context information corresponding to the event, although in continuous care situations this might not always be used. Persistent Compositions do not include this, although if it is necessary to determine what clinical session (if any) caused an update to a persistent Composition, the Contribution can be found from the audit, and then checked for the presence of an event Composition.

4.2.6 Versioning Scenarios

The following scenarios for creating new COMPOSITION versions have been identified as follows.

- Case 0:* information is authored locally, causing the creation of a new VERSION<COMPOSITION>. If this is the first version, a new VERSIONED_COMPOSITION will be created first.
- Case 1:* information is modified locally, such as for the correction of a wrongly entered datum in a composition. This causes the creation of a new VERSION<COMPOSITION> in an existing VERSIONED_COMPOSITION, in which the AUDIT_DETAILS.*change_type* is set to “correction”.
- Case 2:* information received from a feeder system, e.g. a test result, which will be converted and used to create a new VERSION<COMPOSITION>. This kind of acquisition could be done automatically. If the receiver system needs to store a copy of the original feeder system audit details, it writes it into the COMPOSITION.*feeder_audit*.
- Case 3:* a VERSION<COMPOSITION> (such as a family history) received as part of an EHR_EXTRACT from another openEHR system, which will be used by a local author to create a new COMPOSITION that includes some content chosen from the received item. In this case, the new VERSION<COMPOSITION> is considered as a locally authored one, in which some content has been obtained from elsewhere. If it is the first version, a

VERSIONED_COMPOSITION is first created. The AUDIT_DETAILS documents the committal of this content, and the clinician may choose to record some details about it in the audit *description*.

In summary, the AUDIT_DETAILS is always used to document the addition of information locally, regardless of where it has come from. If there is a need to record original audit details, they become part of the content of the versioned object.

5 EHR Package

5.1 Overview

The `ehr` package is illustrated in FIGURE 11. The `EHR` class is the root access point of the health record for a subject of care, and is a change-controlled repository of the kind described in the *openEHR* Common Information Model. Accordingly, it contains the identifiers of various versioned objects, as well as the list of Contributions made to it. The versioned objects consist of:

- an EHR Status object, in the form of a `VERSIONED_EHR_STATUS` instance;
- a directory, in the form of a `VERSIONED_FOLDER` instance (defined in the Common IM);
- Compositions in terms of `VERSIONED_COMPOSITIONS`.

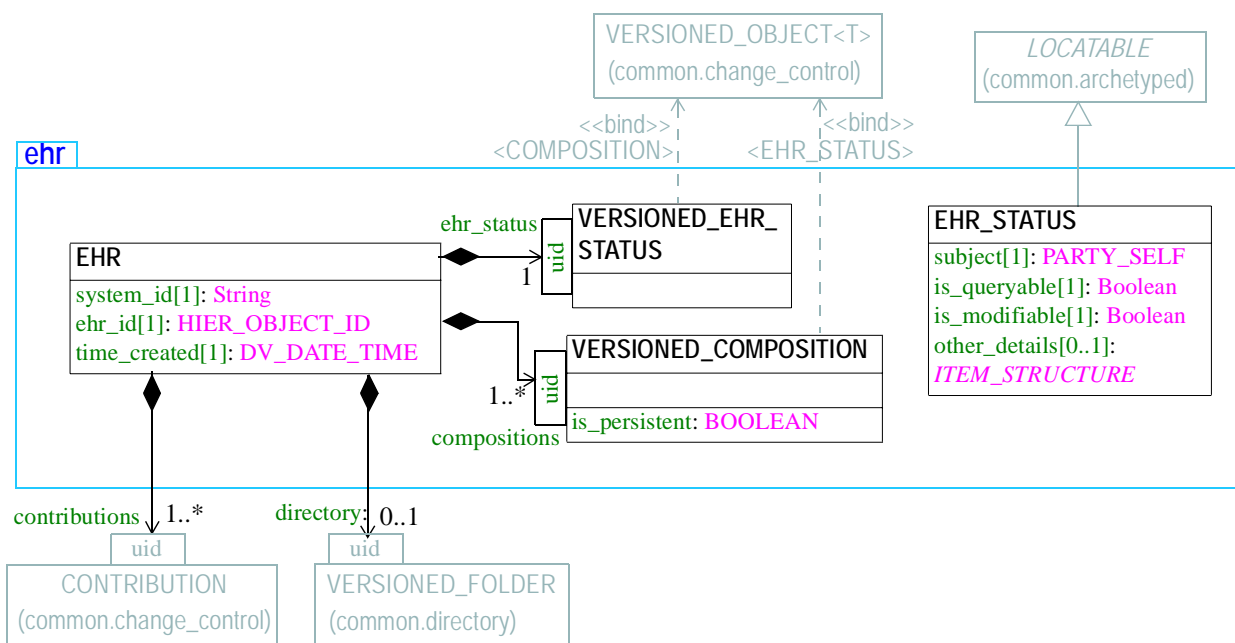

FIGURE 11 `rm.ehr` Package

The root `EHR` object is very simple, and records only the identifier of the system where it was created, the identifier of the `EHR` (distinct from any identifier for the subject of care), and the time of creation. Otherwise, it simply acts as an access point for the content items and Contributions of the `EHR`.

A single `EHR Status` object is included in every *openEHR* `EHR`, and provides a place where `EHR`-wide settings, flags and environmental information can be recorded. It is versioned, so that any change to any part of the content is medico-legally auditable.

The main data of the `EHR` consists of its Compositions. References rather than containment by value are used for the *compositions* relationship between the `EHR` and `VERSIONED_COMPOSITION` classes, reflecting the vast majority of retrieval scenarios in which only select (usually recent) Compositions are needed. Containment by value would lead to systems which retrieved all `VERSIONED_COMPOSITION` objects every time the `EHR` object was accessed.

The directory structure is optional, and consists of `FOLDERS` (defined in the Common IM, *directory* package), enabling the construction of a hierarchical directory of any complexity. Each `Folder`

in the structure can contain any number of references to versioned Compositions. The structure as a whole acts as a directory for organising versioned Compositions in the record.

The use of references between Folders and Compositions allows more than one Folder to refer to the same Composition, thus allowing multiple ways of finding or classifying Compositions. This arrangement is akin to a computer file system that allows links (Unix) or “shortcuts” (Windows); in the EHR it allows for example a contact Composition to be grouped with other Compositions in an episode, and also in a group corresponding to a type of problem. The sophistication of the folder structure is completely under the control of the designers of EHR systems, and can be as simple or complex as required, according to the use of archetypes. The whole Folder structure may correspond to one archetype, or there may be multiple archetypes used to create it.

The same logic holds for the relationship between the EHR and its CONTRIBUTIONS. The role of Contributions, as documented in the Common Information Model, is to record the set of versions added to a repository during a single logical update, along with the audit details of the change. In the context of the EHR as one such repository, each instance of the CONTRIBUTION class potentially includes in its list of versions not only compositions, but also the folder structure itself, if this was changed during the update. Since the *versions* attribute of the CONTRIBUTIONS class is in fact a list of OBJECT_REFS, the same list can accommodate both types of object.

5.2 EHR Creation Semantics

When an EHR is created, the result should be a root EHR object and an EHR Status object, plus any other house-keeping information the versioning implementation requires. In a normal implementation, the EHR Status object would normally be created and committed in a Contribution, just as any Composition would be. The EHR Status object has a special status in the EHR, indicating whether the EHR should be included in querying, whether it is modifiable, and by implication, whether it is active. Flags might be set to indicate that it is test record, or for educational or training purposes. The initial creation operation has to supply sufficient parameters for creation of these two objects, including:

- system id
- EHR id
- Subject id (optional; the use of PARTY_SELF allows completely anonymous EHRs)
- queryable flag
- modifiable flag
- any other flags required by the EHR Status object in the local implementation.

5.3 Time in the EHR

There are numerous times recorded in the EHR, at varying levels of granularity. The following figure indicates the main ones common to Observation recordings (generally the most numerous) in the

EHR. These times have a close correspondence with the contexts described in Context Model of Recording on page 16.

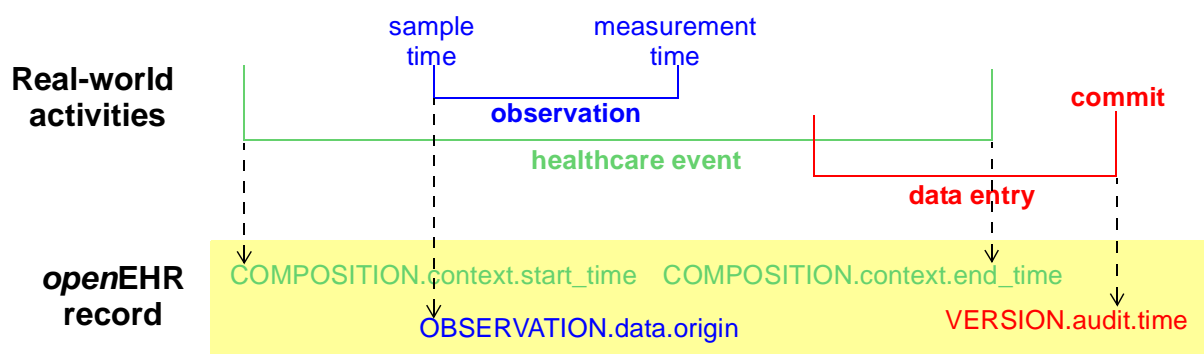

FIGURE 12 Time in the EHR

5.4 Historical Views of the Record

It is important to understand that the `COMPOSITION` versions at a previous point in time represent a previously available *informational state* of the EHR, at a particular EHR node. Such previous states include only those Compositions from other sources as have been acquired by that point in time, *regardless of whether the acquired information pertains to clinical information recorded earlier*. A previous historical state of the EHR thus corresponds to what users of a system could see at a particular moment of time. It is important to differentiate this from previous *clinical* states of the patient: previous *informational* states of the EHR might include acquired information which is significantly older than the point in time when merging occurred. A previous clinical state of the patient would be a derivable view of the EHRs in all locations for the patient - what is sometimes called the virtual EHR - at a given point in time, minus acquired Compositions, since these constitute (usually out-of-date) copies of Compositions primarily available elsewhere.

It is previous informational states with which we are concerned for medico-legal purposes, since they represent the information actually available to clinicians at a health-care facility, at a point in time. But previous clinical views may be useful for reconstructing an actual sequence of events as experienced by the patient.

5.5 Class Descriptions

5.5.1 EHR Class

CLASS	EHR
Purpose	The <code>EHR</code> object is the root object and access point of an EHR for a subject of care.
CEN	EHCR class
Synapses	RecordFolder class
GEHR	G1_EHR

CLASS	EHR	
Attributes	Signature	Meaning
1..1	system_id: HIER_OBJECT_ID	The id of the EHR system on which this EHR was created.
1..1	ehr_id: HIER_OBJECT_ID	The id of this EHR.
1..1	time_created: DV_DATE_TIME	Time of creation of the EHR
1..1	contributions: List<OBJECT_REF>	List of contributions causing changes to this EHR. Each contribution contains a list of versions, which may include references to any number of VERSION instances, i.e. items of type VERSIONED_COMPOSITION and VERSIONED_FOLDER.
1..1	ehr_status: OBJECT_REF	EHR_STATUS object for this EHR.
0..1	directory: OBJECT_REF	Optional directory structure for this EHR.
1..1	compositions: List <OBJECT_REF>	Master list of all composition references in this EHR
Invariants	<i>System_id_valid:</i> system_id /= Void <i>Ehr_id_valid:</i> ehr_id /= Void <i>Time_created_valid:</i> time_created /= Void <i>Contributions_valid:</i> contributions /= Void and then contributions.for_all(type.is_equal("CONTRIBUTION")) <i>Compositions_valid:</i> compositions /= Void and then compositions.for_all(type.is_equal("VERSIONED_COMPOSITION")) <i>Directory_valid:</i> directory /= Void implies directory.type.is_equal("VERSIONED_FOLDER")	

5.5.2 VERSIONED_EHR_STATUS Class

CLASS	VERSIONED_EHR_STATUS	
Purpose	Versioning container for EHR_STATUS instance.	
Inherit	VERSIONED_OBJECT<EHR_STATUS>	
Attributes	Signature	Meaning
Invariants		

5.5.3 EHR_STATUS Class

CLASS	EHR_STATUS	
Purpose	Single object per EHR giving various EHR-wide information.	
Inherit	LOCATABLE	
Attributes	Signature	Meaning
1..1	subject: PARTY_SELF	The subject of this EHR. The <i>external_ref</i> attribute can be used to contain a direct reference to the subject in a demographic or identity service. Alternatively, the association between patients and their records may be done elsewhere for security reasons.
1..1	is_queryable: Boolean	True if this EHR should be included in population queries, i.e. if this EHR is considered active in the population.
1..1	is_modifiable: Boolean	True if this EHR is allowed to be written to.
0..1	other_details: ITEM_STRUCTURE	Any other details of the EHR summary object, in the form of an archetyped Item_structure.
Invariants	<i>Is_archetype_root:</i> is_archetype_root <i>Subject_valid:</i> subject /= Void <i>No_parent:</i> parent = Void	

5.5.4 VERSIONED_COMPOSITION Class

CLASS	VERSIONED_COMPOSITION	
Purpose	Version-controlled composition abstraction, defined by inheriting VERSIONED_OBJECT<COMPOSITION>.	
GEHR	G1_VERSIONED_COMPOSITION	
Inherit	VERSIONED_OBJECT<COMPOSITION>	
Function	Signature	Meaning
	is_persistent: Boolean	Indicates whether this composition set is persistent; derived from first version.

CLASS	VERSIONED_COMPOSITION
Invariants	<i>Archetype_node_id_valid</i> : all_versions.for_all ((c:COMPOSITION) c.archetype_node_id.is_equal(all_versions.first.archetype_node_id)) <i>Persistent_valid</i> : all_versions.for_all ((c:COMPOSITION) c.is_persistent = all_versions.first.data.is_persistent) <i>Owner_id_valid</i> : owner_id.generating_type.is_equal("EHR")

6 Composition Package

6.1 Overview

The Composition is the primary ‘data container’ in the *openEHR* EHR and is the root point of clinical content. Instances of the Composition class can be considered as self-standing data aggregations, or documents in a document-oriented system (similar to HL7 CDA Documents). The key information in a COMPOSITION is found in its *content*, *context*, and *composer* attributes. The majority of the use of paths in *openEHR* is likely to be within Compositions. FIGURE 13 illustrates the composition package.

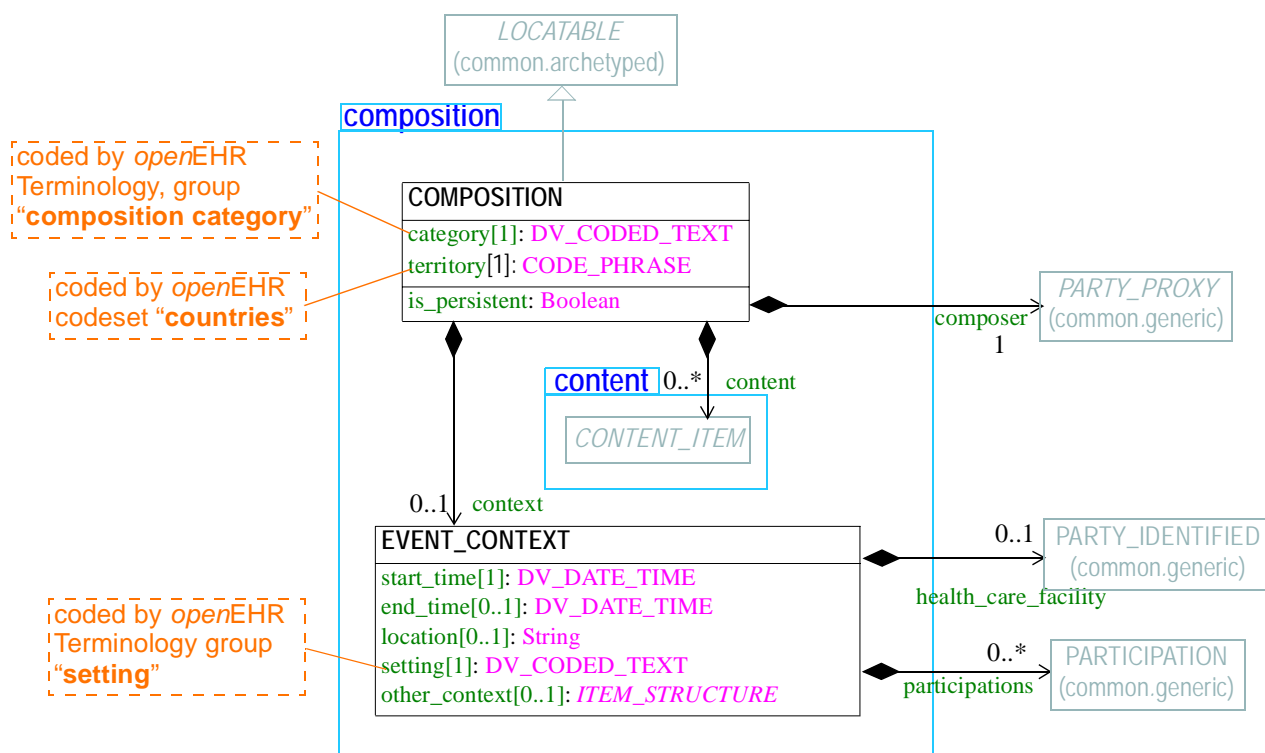

FIGURE 13 rm.composition Package

6.2 Design Principles

6.2.1 Composition Composer

The *composer* is the person who was primarily responsible for the content of the Composition. This is the identifier which should appear on the screen. It could be a junior doctor who did all the work, even if not legally responsible, or it could be a nurse, even if later attested by a more senior clinician; it will be the patient in the case of patient-entered data. It may or may not be the person who entered and committed the data. It may also be a software agent. This attribute is mandatory, since all content must be been created by some person or agent.

Since in many cases Compositions will be composed and committed by the same person, it might seem that two identifiers `COMPOSITION.composer` and `VERSION.audit.committer` (which are both of type `PARTY_PROXY`) will be identical. In fact, this will probably not be the case, because the kind of identifier to represent the composer will be a demographic identifier, e.g. “RN Jane Williams”, “RN

12345678”, whereas the identifier in the audit details will usually be a computer system user identifier, e.g. “jane.williams@westmead.health.au”. This difference highlights the different purposes of these attributes: the first exists to identify the clinical agent who created the information, while the second exists to identify the logged-in user who committed it to the system.

In the situation of patient-entered data, the special “self” `PARTY_PROXY` instance (see Common IM generic package) is used for both `COMPOSITION.composer` and `VERSION.audit.committer`.

6.2.2 Event Context

Overview

The optional *event_context* in the `COMPOSITION` class is used to document the healthcare event causing new or changed content in the record. Here, ‘healthcare event’ means ‘a (generally billable) business activity of the healthcare system with, for or on behalf of the patient’. Generally this will an encounter involving the subject of care and physician, but is variable in a hospital environment. In this sense, a visit to a GP is a single care event, but so is an episode in a hospital, which may encompass multiple encounters. The information recorded in Event context includes start and (optional) end time of the event, health care facility, setting (e.g. primary care, aged care, hospital), participating healthcare professionals, and optional further details defined by an archetype.

Healthcare events that require an `Event_context` instance in their recorded information include the following.

- Scheduled or booked patient encounters leading to changes to the EHR, including with a GP, hospital consultant, or other clinical professional such as mobile nurse. In this case, the Event context documents the time and place of the encounter, and the identity of the clinical professional.
- Case conferences about a patient, leading to modifications to the health record; here the Event context documents the case conference time, place and participants.
- Pathology, imaging or other test process. In this case, the Event context documents the place and period during which testing and analysis was carried out, and by whom.
- Data resulting from care in the home provided by health professional(s) (often allied health care workers).

Situations in which Event context is optional include the following.

- Nurse interactions with patients in hospital, including checking vital signs, adjusting medication or other aspects of bed situation for the patient. Each instance of a nurse’s observations are generally not considered to be a separate ‘care event’, rather they are seen as the continuation of the general activities of monitoring. In such situations, the overall context is given by `ADMIN_ENTRY` instances in the record indicating date/time and place of admission and discharge.

Situations in which Event context is not used include:

- Any modification to the EHR which corrects or updates existing content, including by administrative staff, and by clinical professionals adding or changing evaluations, summaries etc.
- Patient-entered data where no interaction with health professionals took place; typically readings from devices in the home such as weighing scales, blood glucose measuring devices, wearable monitors etc.

Ultimately, the use of Event context will be controlled by Composition-level archetypes.

Occurrence in Data

For situations requiring an EVENT_CONTEXT object to be recorded, it is worth clarifying which Compositions carry such objects. Consider the example shown in FIGURE 14. In this example, a Contribution is made to the EHR, consisting of one or more Compositions that were each created or modified due to some clinical activity. Within such a set, there will usually be one Composition relating directly to the event, such as the patient contact - this is the Composition containing the doctor's observations, nurses' activities etc, during the visit, and is therefore the one which contains the EVENT_CONTEXT instance. Other Compositions changed during the same event (e.g. updates to medication list, family history and so on) do not require an Event context, since they are part of the same Contribution, and the event context of the primary Composition can always be retrieved if desired. Contributions A, B and C in the figure illustrate this case.

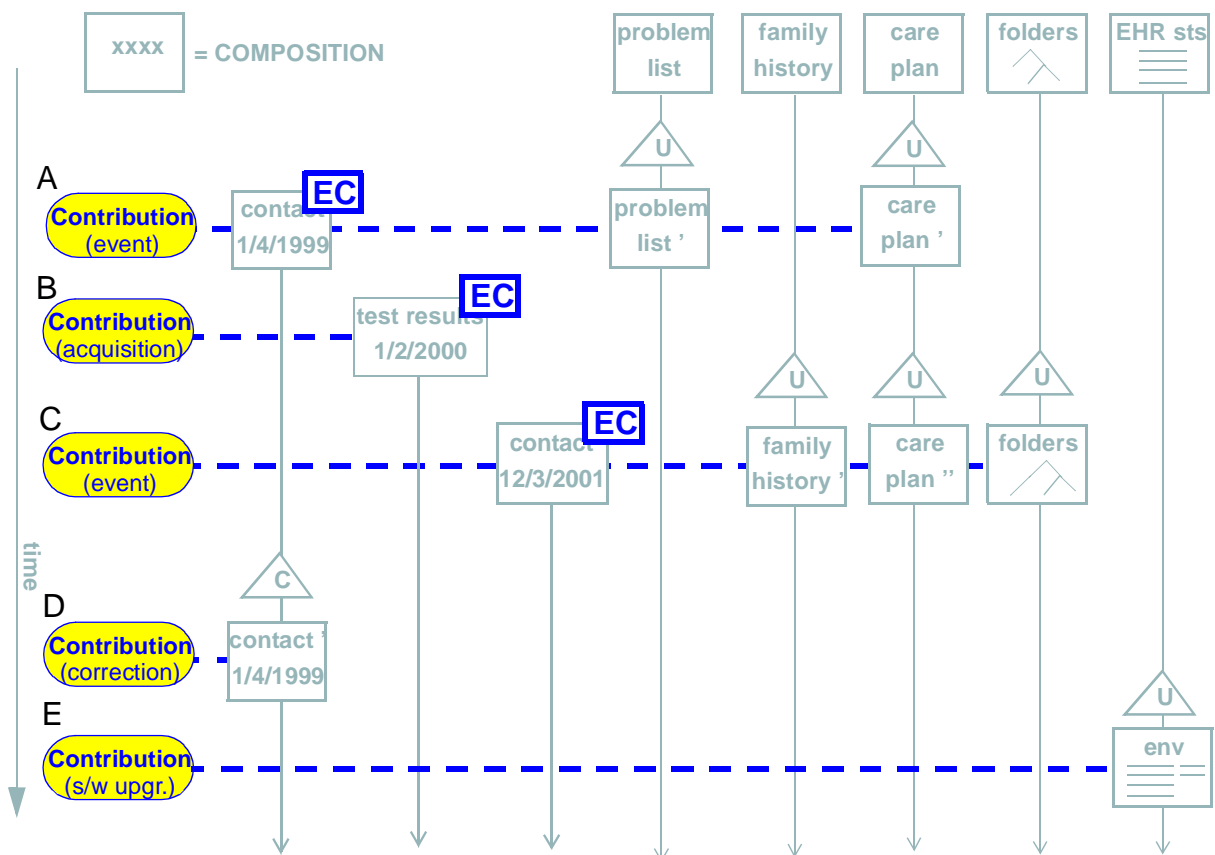

FIGURE 14 Use of Event context

In cases where Contributions are made to the record with no event context, the Event context of any Compositions from the original commit will remain intact and visible (unless the correction is to the event context itself of course), and will correctly reflect the fact that no new clinical interaction occurred. This is the case with Contribution D in the figure.

Persistent Compositions do not have an Event context.

Time

The times recorded in the Event context represent the time of an encounter or other activity undertaken by a health provider to/for/on behalf of the patient. The time is represented as a mandatory start time and optional end time. It is assumed that where there is a clinical session (i.e. an EVENT_CONTEXT object does exist), the start time is known or can be reasonably approximated. It is

quite common that the end time of a consultation or encounter is not recorded, but rather inferred from e.g. average consult times, or the start time of the next consult for the same physician.

Event context is used as described above even if the additions are made to the EHR long after the event took place, such as happens when a doctor writes his/her notes into the record system at night, after all patients have been seen. In such cases, the versioned Composition audit trail records the context of when the data were entered, as distinct from the context of when the clinical interaction took place.

Participations

As part of the Event context, the *participations* attribute can be used to describe who participated, and how. Each participation object describes the “mode” of participation as well, such as direct presence, video-conference and so on. In many cases such information is of no interest, since the subject of any Entry is known (*ENTRY.subject*) and the clinician will be known (*COMPOSITION.composer*), and the mode of communication is assumed to be a personal encounter. The *participations* attribute is therefore used when it is desired to record further details of how the patient and or physician interacted (e.g. over the internet), and/or other participants, such as family, nurses, specialists etc.

There are no general rules about who is included as a participant. For example, while there will be a patient participation during a GP visit, there will be no such participation recorded when the clinical event is a tissue test in a laboratory. Conversely, a patient might record some observations and drug self-administration in the record, in which case the composer will be the patient, and there will be no clinician participation. Consequently, the use of participations will mostly be archetype-driven.

Healthcare Facility, Location and Setting

The *health_care_facility* (HCF) attribute is used to record the health care facility in whose care the event took place. This is the most specific identifiable (i.e. having a provider id within the health system) workgroup or care delivery unit within a care delivery enterprise which was involved in the care event. The identification of the HCF can be used to ensure medico-legal accountability. Often, the HCF is also where the encounter physically took place, but not in the case of patient home visits, internet contacts or emergency care; the HCF should not be thought of as a physical place, but as a care delivery management unit. The physical place of care can be separately recorded in *EVENT_CONTEXT.location*. The *health_care_facility* attribute is optional to allow for cases where the clinical event did not involve any care delivery enterprise, e.g. self-care at home by the patient, emergency revival by a non-professional (e.g. CPR by lifeguard on a beach), care by a professional acting in an unofficial capacity (doctor on a plane asked to aid a passenger in difficulty). In all other cases, it is mandatory. Archetypes are used to control this.

Two other context attributes complete the predefined notion of event context in the model: *location* and *setting*. The *location* attribute records: the physical location where the care delivery took place, and should document a reasonably specific identifiable location. Examples include “bed 5, ward E”, “home”. This attribute is optional, since the location is not always known, particularly in legacy data.

The *setting* attribute is used to document the “setting” of the care event. In clinical record keeping, this has been found to be a useful coarse-grained classifier of information. The openEHR Terminology “setting” group is used to code this attribute. It is mandatory, on the basis that making it optional will reduce its utility for querying and classification.

6.2.3 Composition Content

The data in a Composition is stored in the *content* attribute. There are four kinds of data structuring possible in the *content* attribute:

- it may be empty. Although for most situations, there should be content in a Composition, there are at least two cases where an empty Composition makes sense:
 - the first is a Composition in ‘draft’ editing state (*VERSION.lifecycle_state* = ‘incomplete’)
 - the second is for systems that are only interested in the fact of an event having taken place, but want no details, such as so-called clinical ‘event summary’ systems, which might record the fact of visits to the doctor, but contain no further information. This can be achieved using Compositions with event context, and no further content.
- it may contain one or more *SECTIONS* which are defined in the archetype of the Composition;
- it may contain one or more *SECTION* trees, each of which is a separately archetyped structure;
- it may contain one or more *ENTRIES* directly, with no intermediate *SECTIONS*;
- it may be any combination of the last three possibilities.

The actual structures used in a Composition at runtime are controlled by a template, which in turn controls the particular combination of archetypes used.

6.3 Path Semantics

6.4 Class Descriptions

6.4.1 COMPOSITION Class

CLASS	COMPOSITION	
Purpose	One version in a <i>VERSIONED_COMPOSITION</i> . A composition is considered the unit of modification of the record, the unit of transmission in record extracts, and the unit of attestation by authorising clinicians. In this latter sense, it may be considered equivalent to a signed document.	
CEN	Composition	
GEHR	G1_COMPOSITION_VERSION	
Synapses	Composition class	
HL7v3	CDA DOCUMENT	
Inherit	LOCATABLE	
Attributes	Signature	Meaning
0..1	content: <i>List</i> <CONTENT_ITEM>	The content of this Composition.

CLASS	COMPOSITION	
0..1	context: EVENT_CONTEXT	The clinical session context of this Composition, i.e. the contextual attributes of the clinical session.
1..1	composer: PARTY_PROXY	The person primarily responsible for the content of the Composition (but not necessarily its committal into the EHR system). This is the identifier which should appear on the screen. It may or may not be the person who entered the data. When it is the patient, the special “self” instance of PARTY_PROXY will be used.
1..1	category: DV_CODED_TEXT	Indicates what broad category this Composition is belongs to, e.g. “persistent” - of longitudinal validity, “event”, “process” etc.
1..1	territory: CODE_PHRASE	Name of territory in which this Composition was written. Coded from openEHR “countries” code set, which is an expression of the ISO 3166 standard.
Functions	Signature	Meaning
1..1	is_persistent: Boolean	True if category is a “persistent” type, False otherwise. Useful for finding Compositions in an EHR which are guaranteed to be of interest to most users.
Invariants	<i>Is_archetype_root:</i> is_archetype_root <i>Composer_valid:</i> composer /= Void <i>Content_valid:</i> content /= Void implies not content.is_empty <i>Category_validity:</i> category /= Void and then terminology(“openehr”).codes_for_group_name(“composition category”, “en”).has(category.defining_code) <i>Is_persistent_validity:</i> is_persistent implies context = Void <i>Territory_valid:</i> territory /= Void and then code_set(“countries”).has(territory) <i>No_parent:</i> parent = Void	

6.4.2 EVENT_CONTEXT Class

CLASS	EVENT_CONTEXT	
Purpose	Documents the context information of a healthcare event involving the subject of care and the health system. The context information recorded here are independent of the attributes recorded in the version audit, which document the “system interaction” context, i.e. the context of a user interacting with the health record system. Healthcare events include patient contacts, and any other business activity, such as pathology investigations which take place on behalf of the patient.	
CEN	Composition class	
Synapses	Composition class	
HL7v3	TBD	
Attributes	Signature	Meaning
0..1	health_care_facility: PARTY_IDENTIFIED	The health care facility under whose care the event took place. This is the most specific workgroup or delivery unit within a care delivery enterprise that has an official identifier in the health system, and can be used to ensure medico-legal accountability.
1..1	start_time: DV_DATE_TIME	Start time of the clinical session or other kind of event during which a provider performs a service of any kind for the patient.
0..1	end_time: DV_DATE_TIME	Optional end time of the clinical session.
0..1	participations: List <PARTICIPATION>	Parties involved in the healthcare event. These would normally include the physician(s) and often the patient (but not the latter if the clinical session is a pathology test for example).
0..1	location: String	The actual location where the session occurred, e.g. “microbiol lab 2”, “home”, “ward A3” and so on.
1..1	setting: DV_CODED_TEXT	The setting in which the clinical session took place. Coded using the <i>openEHR</i> Terminology, “setting” group.
0..1	other_context: ITEM_STRUCTURE	Other optional context which will be archetyped.

CLASS	EVENT_CONTEXT
Invariants	<p><i>start_time_valid</i>: start_time /= Void</p> <p><i>participations_validity</i>: participations /= Void <i>implies not</i> participations.is_empty</p> <p><i>location_valid</i>: location /= Void <i>implies not</i> location.is_empty</p> <p><i>setting_valid</i>: setting /= Void <i>and then</i> Terminology("openehr").codes_for_group_name("setting", "en").has(setting.defining_code)</p>

7 Content Package

7.1 Overview

The content package contains the `CONTENT_ITEM` class, ancestor class of all content types, and the navigation and entry packages, which contain `SECTION`, `ENTRY` and related types. The content package is illustrated in FIGURE 15.

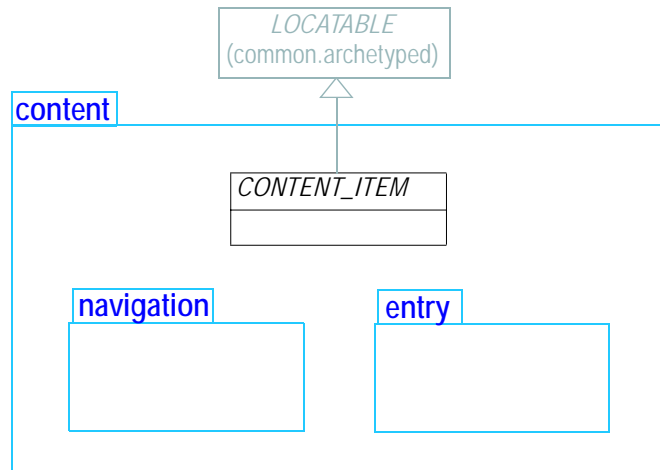

FIGURE 15 rm.composition.content package

7.2 Class Descriptions

7.2.1 CONTENT_ITEM Class

CLASS	<i>CONTENT_ITEM (abstract)</i>	
Purpose	Abstract ancestor of all concrete content types.	
Inherit	CONTENT_ITEM	
Attributes	Signature	Meaning
Invariants		

8 Navigation Package

8.1 Overview

The `navigation` Package defines a hierarchical heading structure, in which all individual headings are considered to belong to a “tree of headings”. Each heading is an instance of the class `SECTION`, illustrated in **FIGURE 16**.

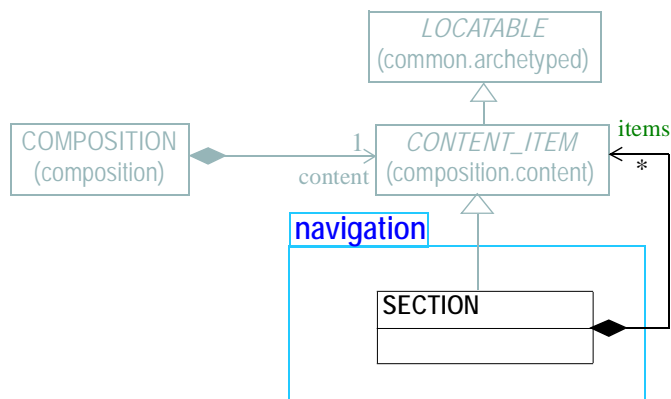

FIGURE 16 `rm.composition.content.navigation` Package

Sections provide both a logical structure for the author to arrange Entries, and a navigational structure for readers of the record, whether they be human or machine. Sections are archetyped in trees with each tree containing a root Section, one or more sub-sections, and any number of Entries at each node. Section trees that are separately archetyped, such as the SOAP headings, or the heading structure for a physical examination, can be combined at runtime by type to form one large heading structure, as shown in **FIGURE 17**.

In terms of understanding of clinical data, Section structures are not essential in a Composition - they can always be removed or ignored (typically in machine processing such as querying) without losing the meaning of the Entries in the Composition. While Sections are often used to group Entries according to status, e.g. “family history”, “problems”, “observations”, it is the Entries themselves that indicate the definitive category of information contained therein. This principle is explained in more detail in `Entry` and its Subtypes on page 50.

Despite the above, Section structures do not have to be regarded as *ad hoc* or unreliable structures. On the contrary, as they are archetyped, their structures can be relied upon in the same way as any other structure in the record can be relied on to conform to its archetype. Accordingly, solid assumptions can be made about Sections, based on their archetypes, for the purposes of querying. In fact, the main benefit of Sections is that they may provide significant performance benefits to querying, whether by interactive application or by automated systems.

One potentially confusing aspect of any Section structure is that while the root Section in a tree is logically a Section, it would not appear in a display or printed form as a visible section, due to the fact that humans don’t usually write down top-level headings for anything, since there is always a containing structure acting as a top-level organising context (such as the piece of paper one is writing on). For example, consider the way a clinician writes down the problem/SOAP headings on paper. She writes the name of the first problem, then under that, the S/O/A/P headings, then repeats the process for further problems. But she doesn’t write down a heading above the level of the problems, even though there must be one from a data structure point of view.

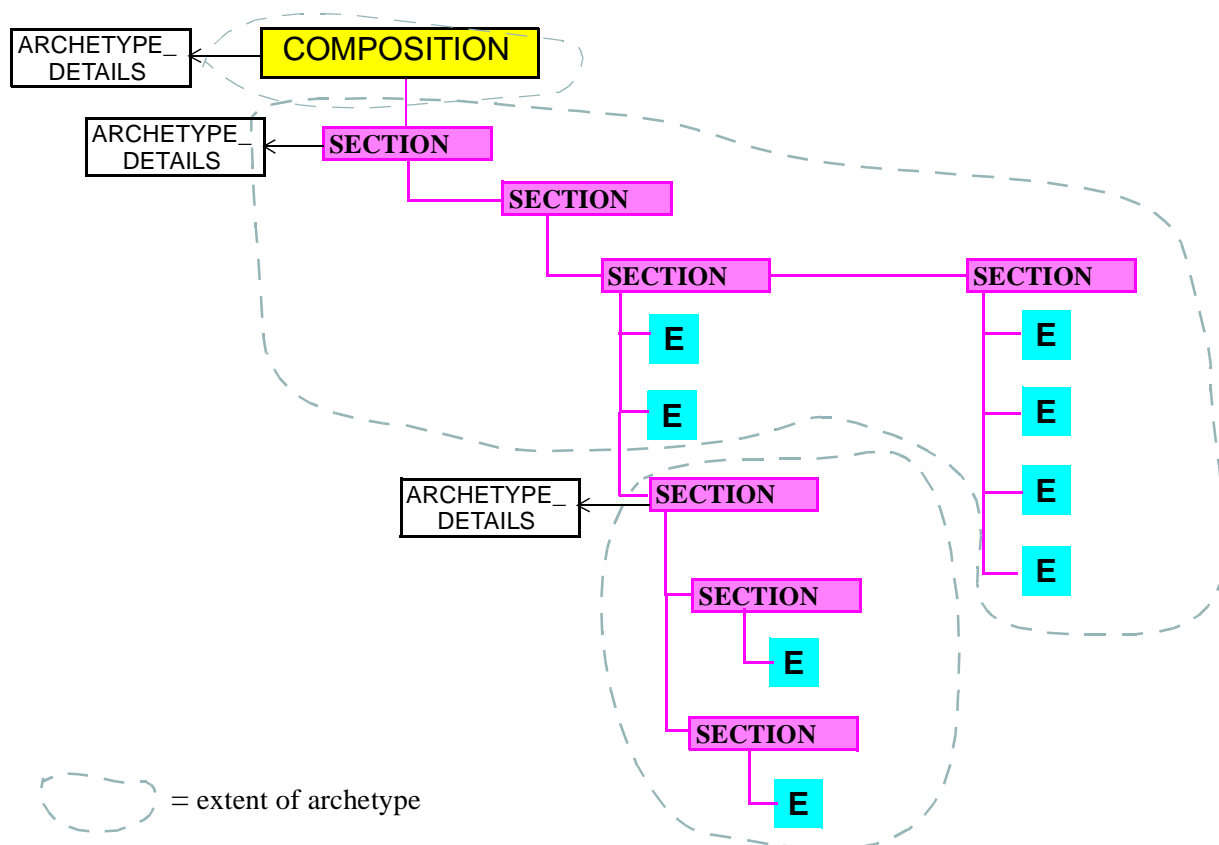

FIGURE 17 Section View of a General Practice Contact Composition

8.2 Class Descriptions

8.2.1 SECTION Class

CLASS	SECTION
Purpose	Represents a heading in a heading structure, or “section tree”.
Use	Created according to archetyped structures for typical headings such as SOAP, physical examination, but also pathology result heading structures.
MisUse	Should not be used instead of ENTRY hierarchical structures.
CEN	Headed_section
OMG HDTF	COAS::CompositeObservation (COAS does not distinguish between the semantics of Sections and hierarchical structure inside Entries, modelled in <i>openEHR</i> by Cluster).
GEHR	G1_ORGANISER
HL7v3	CDA Heading.
Inherit	CONTENT_ITEM

CLASS	SECTION	
Attributes	Signature	Meaning
0..1	items: List<CONTENT_ITEM>	Ordered list of content items under this section, which may include: <ul style="list-style-type: none"> • more SECTIONs • ENTRYs
Invariants	<i>Items_valid:</i> items /= Void <i>implies not</i> items.is_empty	

8.3 Section Instance Structures

8.3.1 Problem/SOAP Headings

An example of an section tree representing the problem/SOAP heading structure is shown in FIGURE 18.

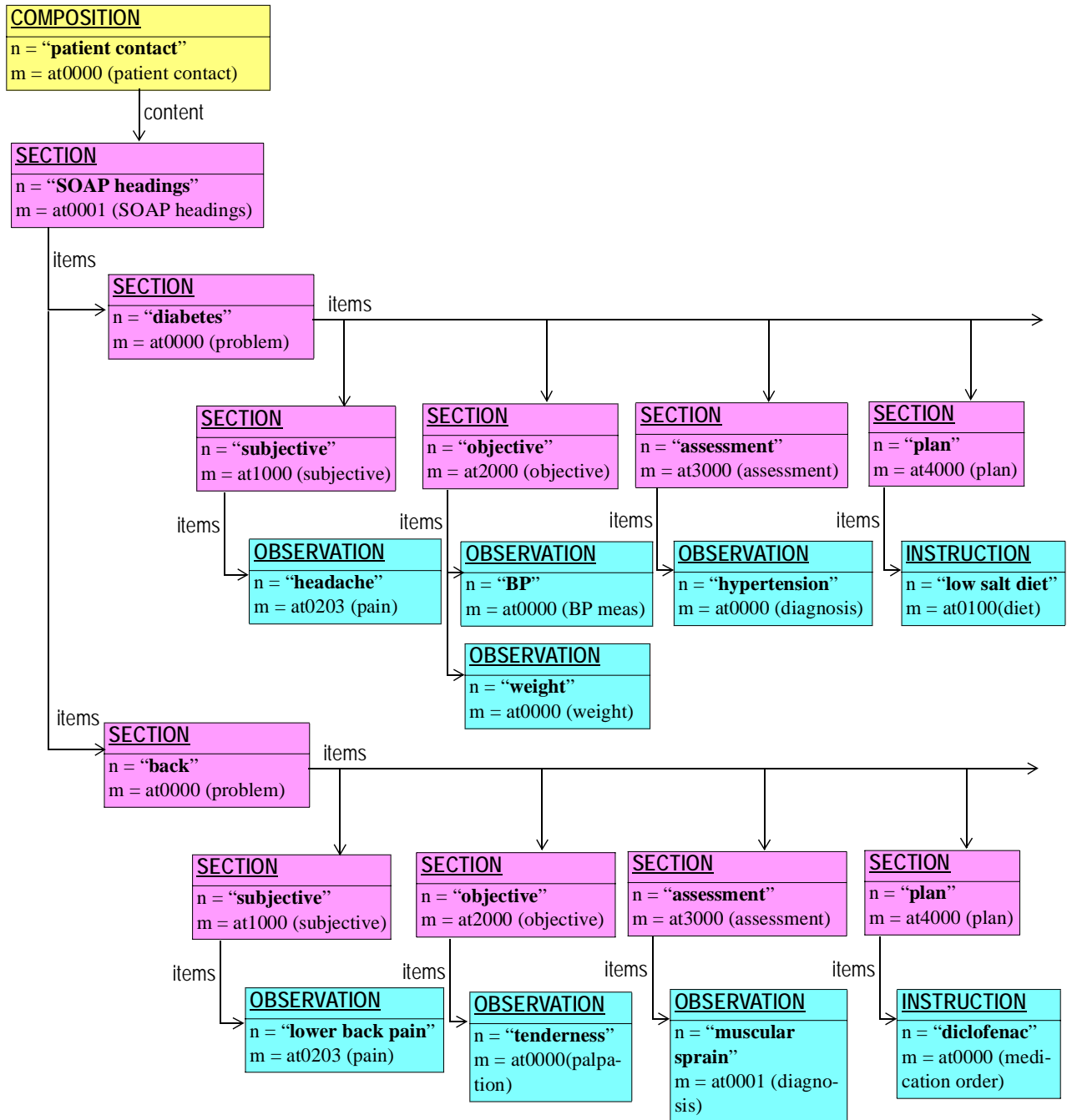

FIGURE 18 "problem/SOAP" Section Structure

9 Entry Package

9.1 Design Principles

9.1.1 Information Typology

All information which is created in the *openEHR* health record is expressed as an instance of a class in the *entry* package, containing the *ENTRY* class and a number of descendants. An *ENTRY* instance is logically a single ‘clinical statement’, and may be a single short narrative phrase, but may also contain a significant amount of data, e.g. an entire microbiology result, a psychiatric examination, a complex prescription. In terms of actual content, the *Entry* classes are the most important in the *openEHR* EHR Information Model, since they define the semantics of all the ‘hard’ information in the record. They are intended to be achetyped, and in fact, archetypes for *Entries* make up the vast majority of important clinical archetypes defined.

The design of *Entry* package is based on past experience and upon a solid theoretical model of clinical recording, described in Beale & Heard [4], which includes a typology of information categories shown in the FIGURE 19 (the *openEHR* *Entry* class names are annotated next to categories which are directly modelled).

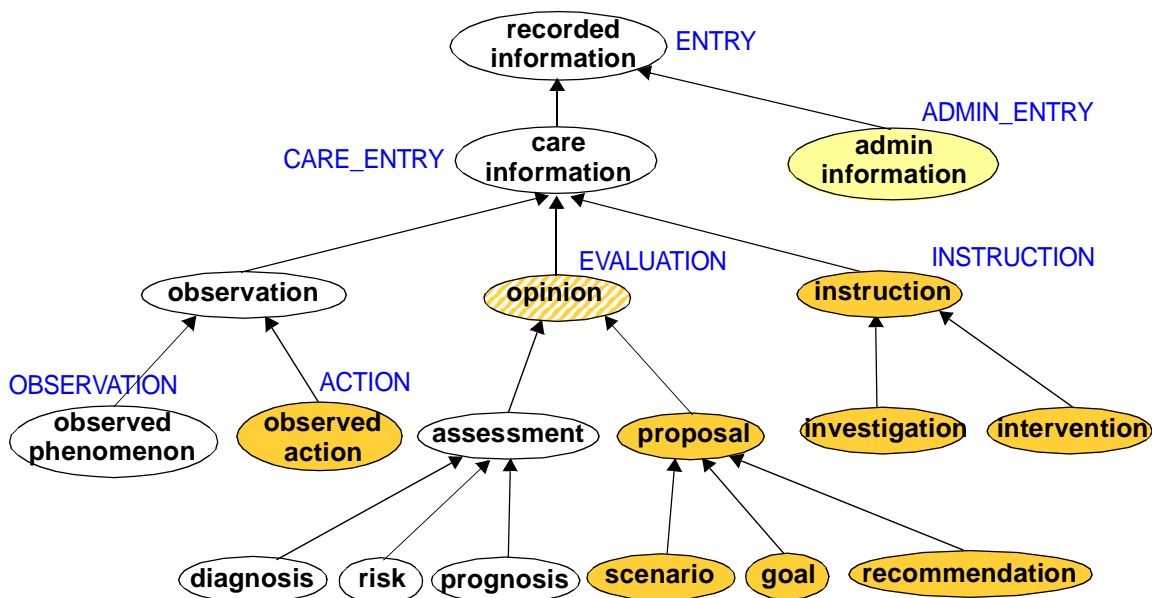

FIGURE 19 Typology of Recorded Information (adapted from Beale & Heard, 2006)

The key top-level categories in the typology are ‘care information’ and ‘administrative information’. The former encompasses all statements that might be recorded at any point during the care process, and consists of the major subcategories ‘observation’, ‘opinion’ and ‘instruction’, which themselves correspond to the past, present and future in time (ISO TC215 uses the terms ‘retrospective’, ‘current’ and ‘prospective’). The administrative information category covers information which is not generated by the care process proper, but relates to organising it, such as appointments and admissions. This information is not about care, but about the logistics of care being delivered. Categories that relate to the patient system as observed and understood are shown as white bubbles, while categories that relate to intervention into the patient system are shown as shaded. The opinion category has features of both passive analysis and active intervention.

Where the principal information categories of FIGURE 19 occur in the care delivery process is shown in FIGURE 20. This figure shows the cycle of information in an iterative, investigation process typical not just of clinical medicine, but of science itself. The system as a whole is made up of two parts: the “patient system” and the “clinical investigator system”. The latter consists of health carers, and may include the patient, and is responsible for understanding the state of the patient system and delivering care to it.

Starting from the patient (right hand side of figure) we can see that Observations lead to Opinions on the part of the investigator, including assessment of the current situation, goals for a future situation, and plans for achieving the goals. The latter lead to Instructions designed to help the patient achieve the goals. A complex or chronic problem may take numerous iterations - possibly a whole lifetime’s worth - with each step being quite small, and future steps depending heavily on past progress. The role of the investigator (and associated agents) is normally filled by health care professionals, but may also be filled by the patient, or a guardian or associate of the patient. Indeed, this is what happens every time a person goes home from the pharmacy with prescribed medication to take at home.

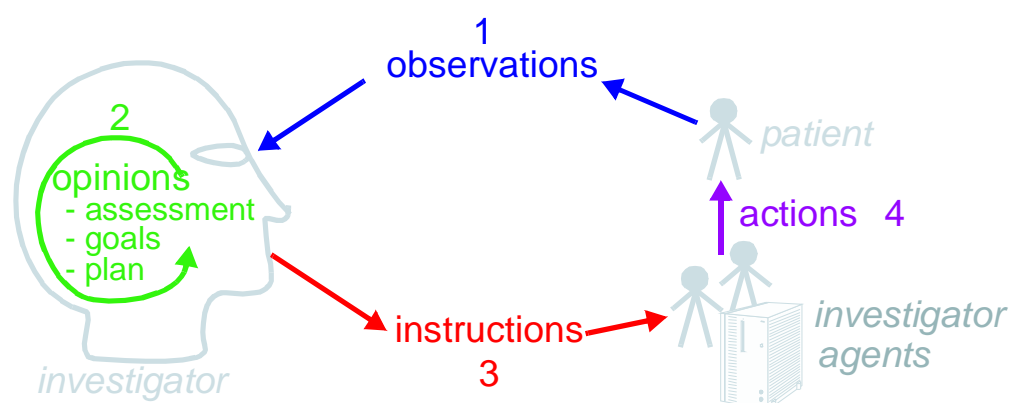

FIGURE 20 Categories of information in the care process

There are two key justifications for using such a typology as a basis for class design. Firstly, although for all categories in the typology there is a meaning for ‘contextual’ attributes of time, place, identity, reason and so on, each category has a different structure for these attributes. For example, time in the Observation category has a linear historical structure, whereas in Instruction it has a branching, potentially cyclic structure. The separation of types allows these contextual attributes to be modelled according to the type. Secondly, the separation of types provides a systematic solution to the so-called problem of “status” or “meaning modification” of clinical statement values, as described below.

9.1.2 Clinical Statement Status

A well-known problem in clinical information recording is the problem of assigning “status”, including variants like “actual value of P” (P stands for some phenomenon), “family history of P”, “risk of P”, “fear of P”, as well as negation of any of these, i.e. “not/no P”, “no history of P” etc. A proper analysis of these so called statuses [4] shows that they are not “statuses” at all, but different categories of information as per the typology. The common statement types mentioned here are mapped as follows:

- actual value of P \Rightarrow Observation (of P);
- no/not P \Rightarrow Observation (of excluded P or types of P, e.g. allergies).
- family history of P \Rightarrow Evaluation (that patient is at risk of P);
- no family history of P \Rightarrow Evaluation (that P is an excluded risk);

- risk of P \Rightarrow Evaluation (that patient is at risk of P);
- no risk of P \Rightarrow Evaluation (that patient is not at risk of P);
- fear of P \Rightarrow Observation (of FEAR, with P mentioned in the description);

Another set of statement types that can be confused in systems that do not properly model information categories concern interventions, e.g. “hip replacement (5 years ago)”, “hip replacement (planned)”, “hip replacement (ordered for next tuesday 10 am)”. Ambiguity is removed here as well, with the use of the correct information categories, e.g. (I stands for an intervention):

- I (distant past) \Rightarrow Observation (of I present in patient);
- I (recent past) \Rightarrow Action (of I having been done to/for patient);
- I (proposed) \Rightarrow Evaluation, subtype Proposal (of I suggested/likely for patient);
- I (ordered) \Rightarrow Instruction (of I for patient for some date in the future).

Correct use of the categories from the typology is facilitated by using archetypes designed to map particular kinds of clinical statement to particular ENTRY subtypes. In a system where Entries are thus modelled, there will be no danger of incorrectly identifying the various kinds of Entries, as long as the Entry subtype, time, and certainty/negation are taken into account.

It is worth recalling the high-level division between EHR and demographic information in *openEHR*. The general approach of *openEHR* is to enable the complete separation of demographic (particularly patient-identification information) from health records, both in the interests of privacy (in some cases required by national legislation) and separated data management. The Demographic IM therefore defines demographic information. However, there is nothing to prevent certain demographic information occurring in the EHR, and in some cases this is desirable. The two main cases for this are:

- clinically-relevant patient information, such as age, sex, height, weight, eye-colour, ethnicity or ‘race’, occupation;
- identifiers and/or names of health care provider individuals and organisations may be stored directly in the EHR, regardless of whether there is also more detailed information about such entities in the demographic system.

The model of all information intended for a separate *openEHR* demographic service (itself usually a front-end to an existing hospital master patient index or similar) is defined in the *openEHR* Demographic Information Model.

9.2 Entry and its Subtypes

The Entry model is defined by the `composition.content.entry` package, shown in FIGURE 21. The choice of subtypes of ENTRY is based on the typology shown in FIGURE 19 and its associated model. The names do not coincide exactly however, for a number of reasons. Firstly, the category names in the hierarchy were chosen based on a philosophical/scientific model of investigation, and reflecting linguistic norms for the meanings of the terms, whereas the class names used here reflect common health computing and clinical usage of these terms (i.e. names which will make sense to software developers in the health arena). Names in these two cultures do not always coincide. Additionally, for categories such as Opinion and Instruction, the subcategories shown in the typology (e.g. Assessment, Goal and Plan) are too variable to safely be subtyped in software, and are distinguished only at the archetype level. Only a single class for each of these ontological groups is used in the formal model. The use of different names and a slightly simplified mapping has not however prevented the faithful implementation of the semantics of the model. The model classes are described in the following subsections.

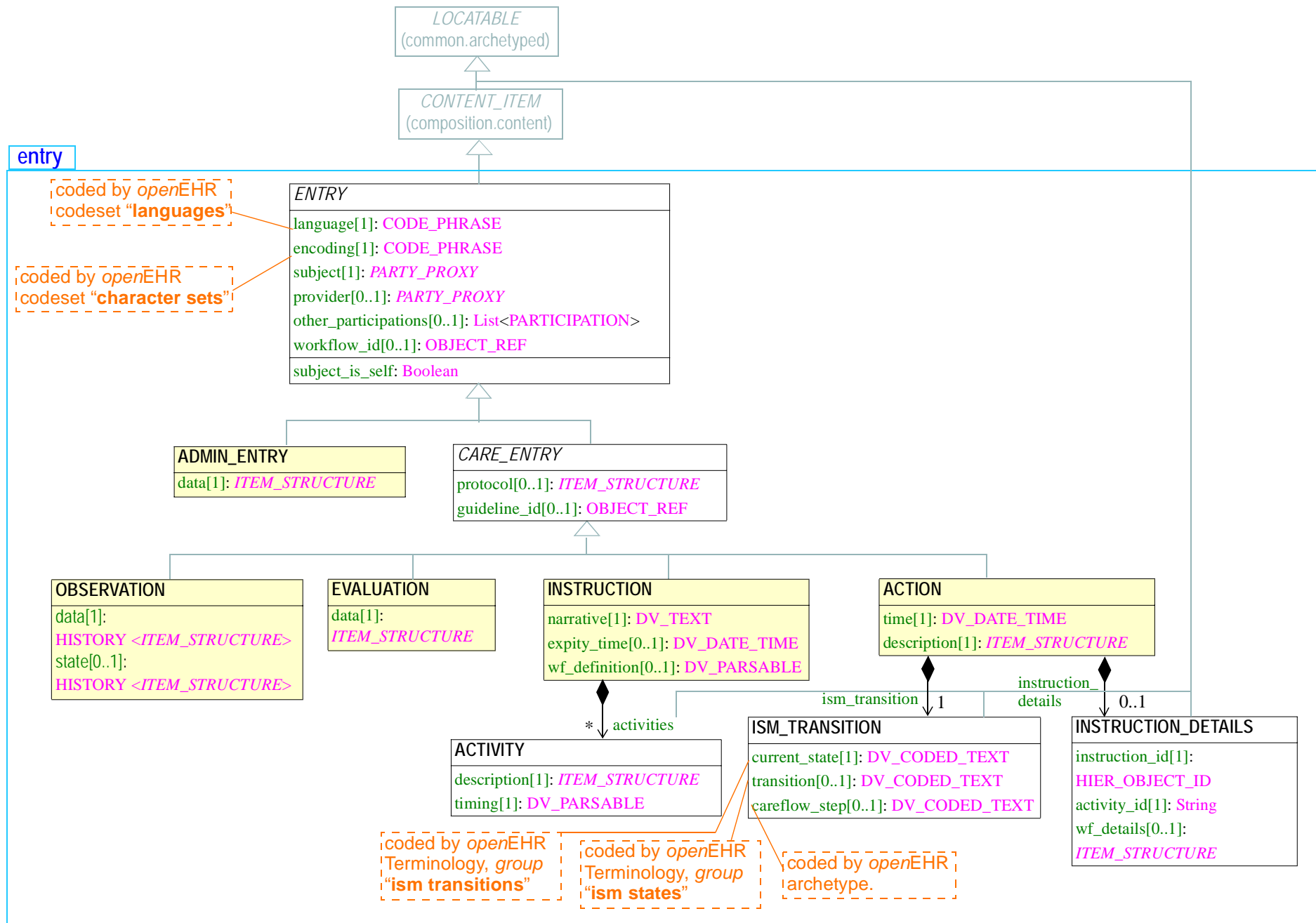

FIGURE 21 rm.composition.content.entry Package

9.2.1 The Entry class

All Entries have a number of attributes in common. The *language* and *encoding* attributes indicate how all text data within the Entry are to be interpreted linguistically and at the character set level. Normally, the language will be the same throughout the entire Entry (if not Composition), but in cases where it is not, the optional language attribute of DV_TEXT can be used to override the value in the enclosing ENTRY (or other enclosing structure, if a DV_TEXT is being used in some other context). Character encoding can be overridden in the same fashion by the *encoding* attribute within DV_TEXT.

The other attributes common to all Entry subtypes are as follows:

subject: this attribute records the subject of the Entry as an instance of a subtype of PARTY_PROXY. When this is the record subject, (i.e. the patient), the value is an instance of PARTY_SELF. Otherwise it is typically a family member, sexual partner, or other acquaintance of the record subject. It could also be an organ donor. The latter is expressed in the form of a PARTY_IDENTIFIED or RELATED_PARTY instance, which describes the kind of relationship, and optionally, identifies the demographic entity.

subject_is_self: convenience function returning True when the Entry is about the subject of the record.

provider: the agent who provided the information. This is usually the patient or the clinician, but may be someone else, or a software application or device. If participation details of the provider (e.g. mode of communication) need to be recorded, the details should be recorded once in the EVENT_CONTEXT.participations. The *provider* attribute is optional, since it is often implicit in the information that was recorded.

other_participations: other participations which existed for this Entry, e.g. a nurse who administered a drug in an INSTRUCTION; only required in cases where participants other than the subject of the information and the provider of the information need to be recorded.

Note that the term ‘provider’ as used here should not be confused with the more specific healthcare term used in many english-speaking countries meaning ‘health care provider’, which is usually understood to be a physician or healthcare delivery enterprise such as a hospital. In the model here, it simply means ‘provider of information’ in the context of an Entry. The information provider is optional, and in many cases will not be recorded, since it will be obvious from the *composer* and *other_participations* of the enclosing Composition. In many cases, it is not sensible to record a provider, e.g. in the most mundane case where a GP asks “where does it hurt” and the patient says “here” - in such cases, it can only be considered mutual. It is expected to be used only when the composer of the Composition really needs to specify the origin of specific statements, such as in the following circumstances:

- the information provider is specifically accountable for the Entry data (it is their opinion, their decision, they carried out the test etc) - they might also need to attest it;
- the information provider is an authoritative source, or has provided information from a unique perspective (e.g. the view of a spouse/ carer on the patient's functional health status or mental state);
- the information provider's view might not reflect the consensus (e.g. a patient opinion not held by the composer, a difference between father and mother on a description of a child's sleeping pattern);
- the information provider is *not* one of the Composition-level participants (e.g. an outside information provider such as someone telephoned during the encounter to provide a lab result, or an automated measurement device, or a decision support software component).

9.2.2 Care_entry and Admin_entry

A basic division occurs between clinical and non-clinical information. The `CARE_ENTRY` class is an abstract precursor of classes that express information of any clinical activity in the care process around the patient, while `ADMIN_ENTRY` is used to capture administrative information. The division may occasionally seem ambiguous at a theoretical level, but at a practical level, it is almost always clear. Administrative information has the following characteristics:

- it is created by non-clinical staff, or clinical staff acting in an administrative capacity (e.g. a nurse or doctor who has to fill out an admission form in A&E);
- it expresses details to do with *coordinating* the clinical process, by recording e.g. admission information (enables clinical staff to know who is in the hospital and where they can be found), appointments (ensuring patient and physician get together at an agreed time and place), discharge/dismissal (allowing clinical staff to know that a patient has been sent home healthy, or transferred to another institution), billing and insurance information (where such information is required in the EHR; it may well be in its own system);
- removing administrative information from the EHR would not compromise its clinical integrity, it would simply mean that carers and patients would no longer know when and where they were supposed to meet, or when the patient has entered or left a health care facility.

Conversely, every instance of a `CARE_ENTRY` subtype is clinically significant, even if it also carries information which might be of interest to other health management functions billing (e.g. ICD10 coded diagnoses), practice management (e.g. date, time and place in an order for day surgery). The `CARE_ENTRY` type includes two attributes particular to all clinical entries, namely *protocol* and *guideline_id*.

These attributes allow the “how” and “why” aspects of any clinical recording to be expressed. Protocol is often recorded for Observations (e.g. staining method in microscopy) and Instructions (e.g.

9.2.3 Observation

Instances of the `OBSERVATION` class record the observation of any phenomenon or state of interest to do with the patient, including pathology results, blood pressure readings, the family history and social circumstances as told by the patient to the doctor, patient answers to physician questions during a physical examination, and responses to a psychological assessment questionnaire. Observations are distinguished from Actions in that Actions are interventions whereas Observations record only information relating to the situation of the patient, not what is done to him/her.

The significant information of an Observation is expressed in terms of “data”, “state” and “protocol”. The first of these is recorded in the *data* attribute, defined as follows:

data: the actual datum being recorded; expressed in the form of a History of Events, each of which can be a complex data structure such as a List, Table, Single (value), or Tree, in its own right. Examples include blood pressure, heartrate, ECG traces.

State information can be recorded in the *state* attribute of Observation, or within the *state* attribute of each Event in the Observation data attribute (see below and also Data Structures IM for more detailed explanations). The state attribute in Observation is defined as follows:

state: any particular information about the state of the subject of the Entry necessary to correctly interpret the data, which is not already known in the health record (i.e. facts such as the patient being female, pregnant, or currently undergoing chemotherapy). For example, exertion level (resting, post-marathon...), position (lying, standing), post- glucose challenge,

and so on. The form of the *state* attribute is the same as that of the *data* attribute: a History of Events of Item_structures.

The inherited *protocol* attribute is defined as follows:

protocol: details of how the observation was carried out, which might include a particular clinical protocol (e.g. Bruce protocol for treadmill exercise ECG) and/or information about instruments other other observational methods. This information can always be safely omitted from the user interface, i.e. has no bearing on the interpretation of the data.

The detailed semantics of Observation data are described in the following subsections.

9.2.3.1 Timing in Observations

Many health information models express observation time as one or more attributes with names like 'observation_time', 'activity_time' and so on. The *openEHR* model departs from this by modelling historical time inside a History/Event structure defined in the `data_structures.history` package¹. In short, this package defines the `HISTORY` class with an *origin* attribute, and a series of `EVENT` instances each containing a *time* attribute. Instantaneous and interval events are distinguished via the `EVENT` subtypes `POINT_EVENT` and `INTERVAL_EVENT`; interval events have the *width* attribute is set to the duration of the interval.

9.2.3.2 Valid Contents of a History

One of the aims of the model of Observation described here is to represent in the same way single sample and multi-sample time-based data for which *measurement protocol is invariant*. It is not intended for measurements in "coarse" time taken by different people, different instruments, or with any other difference in data-gathering technique. In these cases, separate, usually single-sample histories are used, usually occurring in distinct container objects (e.g. distinct Compositions, in the EHR). Accordingly, in the general practice setting, the use of `HISTORY` will correspond to measurement series which occur *during* the clinical session (i.e. during a patient contact). In a hospital setting, nurses' observations might occur in 4-hourly intervals, and there is no well-defined clinical session - simply a series of `ENTRIES` during the time of the episode. Two approaches are possible here.

- If each Observation is to be committed to the EHR as soon as it is made, the result will be distinct `COMPOSITIONS` in time, each with its *event_context* corresponding to the period of the nurse's presence. Each Composition will contain one or more Observations, each containing in their data a History of one sample of the measured vital sign.
- If Observations are not committed to the EHR immediately, but are stored elsewhere and only committed (say) at the end of each day, then the result will be a single Composition whose *event_context* corresponds to the total data gathering period, and which contains Observations whose data are multi-event Histories representing the multiple measurements made over the day.

Whether time-based data remain outside the record until a series of desired length is gathered, or entered as it occurs is up to the design of applications and systems; the approach taken should be based on the desired availability of the data in the system in question. If for example, it must be visible in the EHR as soon as the appropriate Compositions are written, then it should be represented as Histories in each relevant Composition; if it need only be available at some much later point in time (e.g. because it is known that no-one but the treating clinician is interested in it), then it can be stored in another system until sufficient items have been gathered for committal to the EHR.

1. Defined in the Data Structures IM; see http://svn.openehr.org/specification/TRUNK/publishing/architecture/rm/data_structures_im.pdf.

9.2.3.3 Clinical Semantics of Event Time

In most cases, the times recorded in a History (*HISTORY.origin* and *EVENT.time, width*) can be thought of as “the times when the observed phenomena were true”. For example, if a pulse of 88bpm is recorded for 12/feb/2005 12:44:00, this is the time at which the heartrate (for which pulse is a surrogate) existed. In such cases, the *sample* time, and the *measuring* time are one and the same.

However in cases where the time of sampling is different from that of measurement, the semantics are more subtle. There are two cases. The first is where a sample is taken (e.g. a tissue sample in a needle biopsy), and is tested later on, but from the point of view of the test, the time delay makes no difference. This might be because the sample was immediately preserved (e.g. freezing, placed in a sterile anaerobic transport container), or because even if it decays in some way, it makes no difference to the test (e.g. bacteria may die, but this makes no difference to a PCT analysis, as long as the biological matter is not physically destroyed).

The second situation is when the sample does decay in some way, and the delay is relevant. Most such cases are in pathology tests, where presence of live biological organisms (e.g. anaerobic bacteria) is being measured. The sample time (or ‘collection’ time) must be recorded. Depending on when the test is done, the results may be interpreted differently.

The key question is: what is the meaning of the *HISTORY.origin* and *EVENT.time* attributes in these situations? It is tempting to say that their values are (as in other cases) just the times of the actual act of observation, e.g. microscopy, chromatography etc. However, there are two problems with this. Firstly, and most importantly, all physical samples must be understood as being *indirect surrogates for some aspect of the patient state at the time of sampling*, which cannot be observed by direct, instantaneous means in the way a pulse can be taken. This means that no matter when the laboratory work is done, the time to which the result applies is the *sample* time. It is up to the laboratory to take into account time delays and effects of decay of samples in order to provide a test result which correctly indicates the state of the patient at the time of sampling. The common sense of this is clear when one considers the extreme case where the patient is in a coma or dead (possibly for reasons completely unrelated to the problem being tested for) by the time laboratory testing actually occurs; however, the test result indicates the situation at the point in time when the sample was taken, i.e. when the patient was alive. The second reason is that some kinds of testing are themselves lengthy. For example fungal specimens require 4-6 weeks to confirm a negative result; checks will be made on a daily or weekly basis to find positive growth. However, the result data reported by the laboratory (and therefore the structure of the Observation) is not related to the timing of the laboratory testing; it is reported as being the result for the time of collection of the specimen from the patient.

The meaning therefore of the *HISTORY.origin* and *EVENT.time* attributes in *openEHR* is always the time of sampling. Where delays between sample and measurement times exist and are significant, they are noted in the protocol section of the Observation; such times are modelled in the appropriate archetypes, and taken into account in results.

9.2.3.4 Two ways of Recording State

State information is optional, and is not needed if the data are meaningful on their own. If it is recorded, it can either be as a History of its own (i.e. using the *OBSERVATION.state* attribute described above), or else as *state* values within the *EVENT* instances in the *OBSERVATION.data* History. Both methods are useful in different circumstances. A separate state history is more likely to be used in a correlation study such as a sports medicine study on heartrate with respect to specific types of exercise. In this method, the state information is a History of Events whose times and widths need not match those of the History in the *data* attribute. The state data under this approach generally

express the condition of the subject in *absolute* terms, i.e. they are standalone statements about the subject's state at certain points in time, such as "walking on treadmill 10km/h, 10° incline".

The other method will be used in most general medicine, e.g. for recording fasting and post glucose challenge states of a patient undergoing a glucose tolerance test. (See the Data Structures Information Model for more details). State values stored within the *data* History represent the situation in the subject at the time of the Event within the History and usually in relation to it, for example "post 8 hour fast". Recording the latter example in an independent state History would require an Event of 8 hours' duration called 'fast'. The latter would be technically still correct, but would be very unnatural to most clinicians. FIGURE 22 illustrates the two methods of recording state.

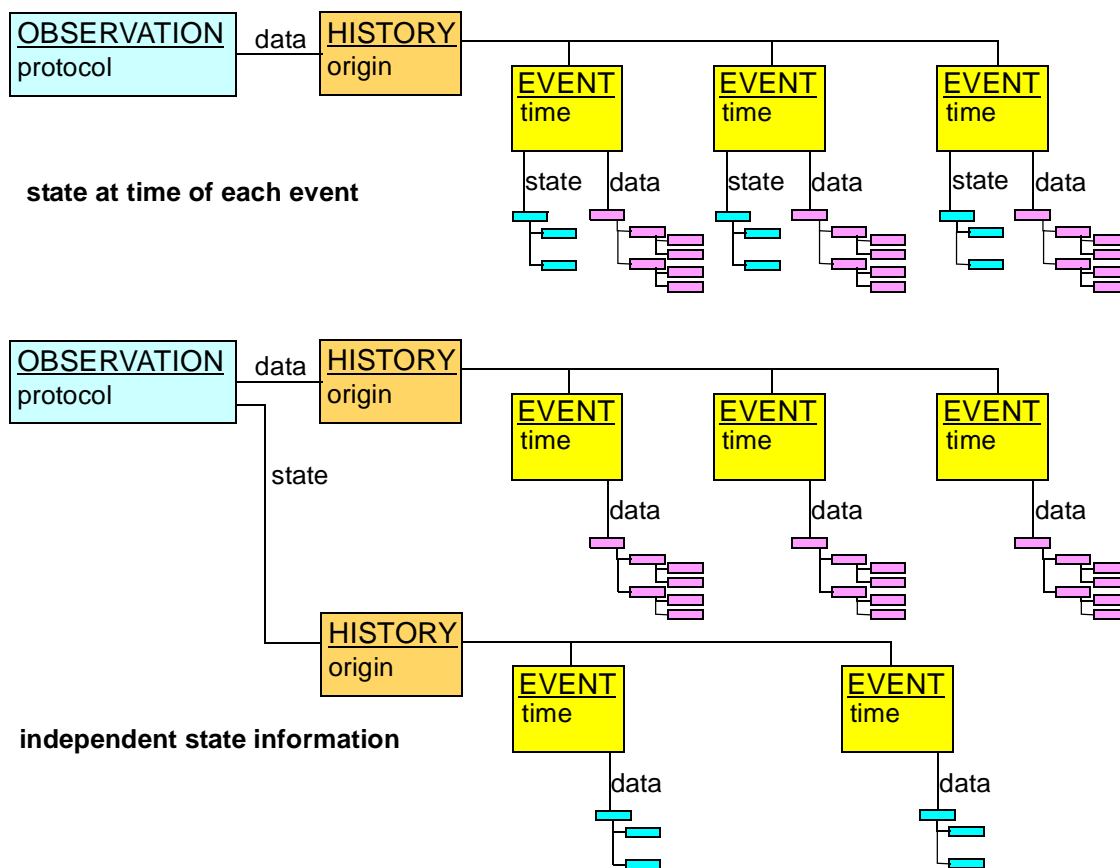

FIGURE 22 Alternative ways of recording state

9.2.4 Evaluation

According to the typology described in [4], the Opinion category covers a number of concrete concepts, as follows.

problem/diagnosis: the assignment of a known diagnosis or problem label to a set of observed signs and symptoms in the patient, for the purpose of determining and managing treatment. The physician will usually include a date of initial onset, date clinically recognised, date of last occurrence, date of resolution of last occurrence and possibly other timing information.

risk assessment: an evaluation of the likelihood and timing of a certain event occurring or condition appearing.

scenario: an opinion about the outcome if a certain intervention is proceeded with.

goal: statement of a target, and a time at which it should be reached.

recommendation: a description in general terms of a suggested care approach for the patient, based on diagnosis; includes various times or time-periods for activities, such as monitoring, taking of medications, and review.

The approach taken to modelling these concepts in *openEHR* is heavily based upon the development of archetypes for assessments such as “diagnosis” (various kinds), “goal”, “adverse reactions”, “alert”, “exclusion”, “clinical synopsis”, “risk based on family history” and so on. Experience has shown that the Opinion category is too variable for safely modelling its sub-categories directly in the reference model. Instead, a single class `EVALUATION` is used for all instances of the Opinion category. (The name Evaluation has been present in *openEHR* for some years, and is retained for reasons of continuity).

The design of the `EVALUATION` class is very simple. In addition to the attributes inherited from `ENTRY` and `CARE_ENTRY`, it has only one attribute, *data*: `ITEM_STRUCTURE`. This structure is intended to be archetyped so as to model all the details of any particular clinical information in the Opinion category. No timing attributes are included, since there is no time associated with creation or capturing of Evaluation information as such, only times included in the information. The only times of generic significance are (potentially) the time of a patient consultation during which the Evaluation was created (recorded in `COMPOSITION.event_context.start_time` and `end_time`) and the time of commitment to the EHR system (recorded in `VERSION.commit_audit` attribute).

The general meaning of the inherited attributes is as for all Entries. In Evaluations, the *provider* is almost always the physician, while the *protocol* may be used to indicate how a particular assessment was made. The *other_participations* attribute is not as likely to be used for Evaluations representing diagnoses, since a diagnosis is usually the result of thinking on the part of the physician; an exception to this would be a case conference or if an expert system were used. However, Plans for complex patients may well be constructed by multiple physicians.

9.2.5 Instruction and Action

Instructions in *openEHR* specify actions to be performed in the future. They differ from information in the Proposal sub-category of Opinion in the typology (i.e. instances of Evaluation in the class model) in that they are specified in sufficient detail to be directly enacted without further clinical decision-making related to the design of the Instruction, e.g. they can be performed by the patient or a nurse. Any decisions that could be made during the performance of an Instruction are either constrained by the Instruction itself (e.g. dose range; suspend if adverse reaction) or else are assumed knowledge of the expected performer. For example, an Evaluation may say that “oral cortico-steroids are indicated at a peak flow of 200 l/m”. A corresponding Instruction would indicate the actual drug, route, dose, frequency, and so on. The informed patient might be reasonably expected to be able to vary the dosage on his or her own within a dosage guideline explained by his/her GP.

In the typology of FIGURE 19, Instructions are further categorised as Investigation and Intervention. However, as for Evaluation, only a single key class, `INSTRUCTION`, is used to model all types of the Instruction category, with archetypes defining the details of the Instruction. A second Entry subtype, `ACTION`, is used to model the information recorded due to the execution of an Instruction by some agent.

The following subsections describe Instruction and Action in some detail.

9.2.5.1 Requirements

The Instruction and Action classes are designed to satisfy the following requirements:

- All kinds of interventions, from simple medication orders to complex multi-drug courses should be representable using the same model;
- Instructions should always have a narrative expression, with an optional machine-processible expression in cases where automation will be used;
- The freedom must exist to model any particular intervention in as much or little detail as required by circumstances;
- Clinicians must be able to specify Instruction steps in their own terms, i.e. using terms like “prescribe”, “dispense”, “start administering”, etc;
- Instructions representing diverse clinical workflows must be queryable in a standard way, so that it can be ascertained what Instructions are ‘active’, ‘completed’ and so on for a patient;
- It should be possible to provide a coherent view of the state of execution of an Instruction even if parts of it have been executed in different healthcare provider environments;
- It must be possible to record *ad hoc* actions in the record, i.e. acts for which no Instruction was defined (at least in the EHR in question);
- Instructions must integrate with notification / alert services;
- An interoperable expression of computable workflow definitions of Instructions will be supported.

9.2.5.2 Design Principles

The design approach is based on four principles. The first is that the *specification* of an Instruction is distinguished from the information representing actions performed as a result. This makes the model and resulting information instances clear to software designers and data users. It also enables workflow engines to determine which parts of the specification have already been executed, and allows for Actions actually performed to differ from those specified. The separation is realised in terms of the `INSTRUCTION` and `ACTION` classes and their helpers. Instances of the former specify an Instruction, while instances of the latter describe steps which have actually been performed.

The second principle is the use of a standard instruction state machine (ISM) defining possible states and transitions for any Instruction, no matter what it is. The use of standardised states means that the execution state of any given Instruction can be characterised in exactly the same way (e.g. ‘planned’, ‘active’, etc), and that it is therefore possible to query the EHR and find out all interventions of any kind in a particular state.

The third principle is to provide a way of mapping steps in any care pathway (i.e. healthcare business process) to states in the Instruction state machine. A care pathway is a process which covers the entirety of steps required to effect an Instruction, including prescribing, booking, dispensing, referring, suspension etc. Any such step when performed leaves the Instruction in one of the states of the ISM.

The fourth principle is to support the expression of the formal workflow definition for an Instruction, where full automation is required. It must be recognised that automation of most therapies and drug administration, as well as other interventions like biopsies is minimal today, and is likely to remain so for some time. This is for the simple reason that the cost of automating most tasks is prohibitive compared to human execution, particularly when Instruction activities can often be executed by healthcare professionals already present for other reasons (e.g. ward nurses). It also has to be said that serious research into the use of workflow automation in healthcare is only quite recent, and that so far, there are no standard models for clinical workflow. In the *openEHR* approach to modelling workflow, such uncertainty is dealt with in two ways. Firstly, formal workflow specification of an Instruction is an optional addition to the base model of Instruction and Action classes, and is not required to obtain

a basic level of computability, including use of the ISM. Secondly, the formal expression of workflow is in the form of parsable syntax rather than objects. This is a generally appropriate design choice, since the safest and most convenient persistent form of a complex formalism is the syntax form rather than the parsed fine-grained object form; this both optimises storage and allows for changes in the syntax over time.

9.2.5.3 Model Overview

Instruction definitions are modelled in terms of the INSTRUCTION and ACTIVITY classes, with optional workflow attributes. These two classes carry the basic information relating to an Instruction, with all formal workflow definition expressed in parsable syntax in the INSTRUCTION.wf_definition attribute. An INSTRUCTION instance includes the narrative description of the Instruction, and a list of ACTIVITY instances. It also includes all the attributes inherited from the CARE_ENTRY class, including *subject*, *participations* and so on.

Most Instructions will have only one Activity, usually describing a medication to be administered and its timing. Some will have more than one drug or therapy, such as the typical 3 drug Losec-HP regime for treating ulcers, and multi-drug chemotherapy. The base Instruction model does not explicitly try to indicate the exact order, serial or parallel administration, or other dependencies, since the knowledge of how to administer the drugs is known by the relevant clinicians, and/or contained in published guidelines. However, the timing information in each Activity does indicate times, days and the usual specifications of “with meals” etc. The timing information is also sufficient to specify a three drug chemotherapy regime, by indicating which days each drug is administered on. It is only when the Instruction is to be automated by a workflow engine that the full structure of the Activity graph will be given. Activity instances may be completely absent from an Instruction, in which case only the narrative will be present. This will typically occur with imported legacy data which itself has no structured representation of medications.

Overall, there are three levels of representation of an Instruction, as shown in FIGURE 23. It is expected that the vast majority of openEHR systems for the foreseeable future will support only the minimal and basic levels.

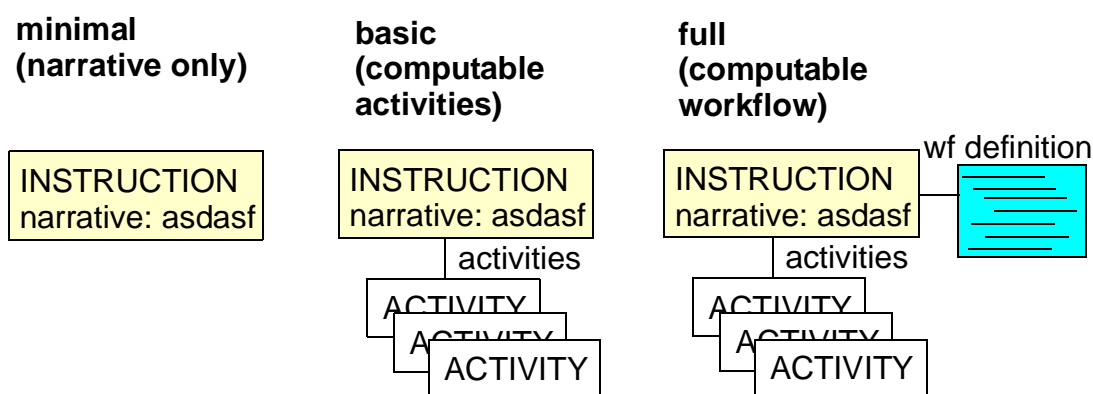

FIGURE 23 Levels of Instruction representation

When some part of an Instruction is executed (or in some cases where there is no Instruction), an ACTION instance is created describing what was done, and committed to the EHR. Actions include the inherited CARE_ENTRY attributes, along with the time of being performed, a description of what was performed, and an ISM_DETAILS object indicating which state of the ISM the Instruction is now in. If the Action did correspond to an Instruction, there will be an INSTRUCTION_DETAILS instance, which indicates which Activity of which Instruction was executed, including workflow execution

details if relevant. Actions for which there is no Instruction (or at least not in the current EHR) do occur fairly often, and will not have the `INSTRUCTION_DETAILS` part of the information. However, they do have the `ISM_DETAILS` instance, and it should always be possible for the committer of an *ad hoc* ACTION to determine what state in the ISM it corresponds to (e.g. to at least be able to say that it is active, suspended, completed etc). In this way, the ISM state of all things happening to the patient can be ascertained by querying, regardless of whether explicit Instructions exist.

9.2.5.4 The Standard Instruction State Machine (ISM)

When a healthcare process is unfolding in a clinical context, EHR users want to know things such as the following:

- what is the current step in the process for the patient?
- for a given patient, what processes are planned, active, suspended, completed?
- for the populations of patients, what is the state of a particular workflow, such as a recall?

The approach chosen here to support such functionality is to define a standard instruction state machine whose state transitions can be mapped to the steps of a specific care pathway, enabling it to be used as a descriptive device for indicating the state of any Instruction. The state machine is illustrated in FIGURE 24. This state machine is the result of long term experience with clinical workflows and act management systems. The states are as follows¹.

INITIAL: initial state, prior to planning activity (default starting state for computable representation of state machine).

PLANNED: the action has been described, but has not as yet taken place.

POSTPONED: the action has not taken place and will not without specific conditions being met. Specifically, events and conditions that would normally ‘activate’ the instruction will be ignored, until a restore event occurs.

SCHEDULED: the action will take place at some designated future time, and has been booked in a scheduling system.

CANCELLED: the action was defined, but was cancelled before anything happened; it has not and will not take place.

ACTIVE: the action is taking place according to its definition. The entire course of medication or therapy corresponds to this state.

SUSPENDED: the action was begun, but has been stopped temporarily, and will not be restarted until explicitly resumed.

ABORTED: the action began but was permanently terminated before normal completion.

COMPLETED: the action began and was completed normally.

EXPIRED: the time during which the action could have been relevant has expired; the action may have completed, been cancelled, or never occurred.

States **CANCELLED**, **ABORTED** and **COMPLETED** are all terminal states. The **EXPIRED** state is a pseudo-terminal state, from which transitions are allowed to proceed to any of the true terminal states, due to information being received after the fact (such as a patient reporting that they did indeed finish a course of antibiotics). However it is likely in the EHR that Instructions for many simple medications will finish in the **EXPIRED** state and remain there.

1. The **SCHEDULED** state was inspired by Van de Velde & Degoulet , Fig 5.5 [15]

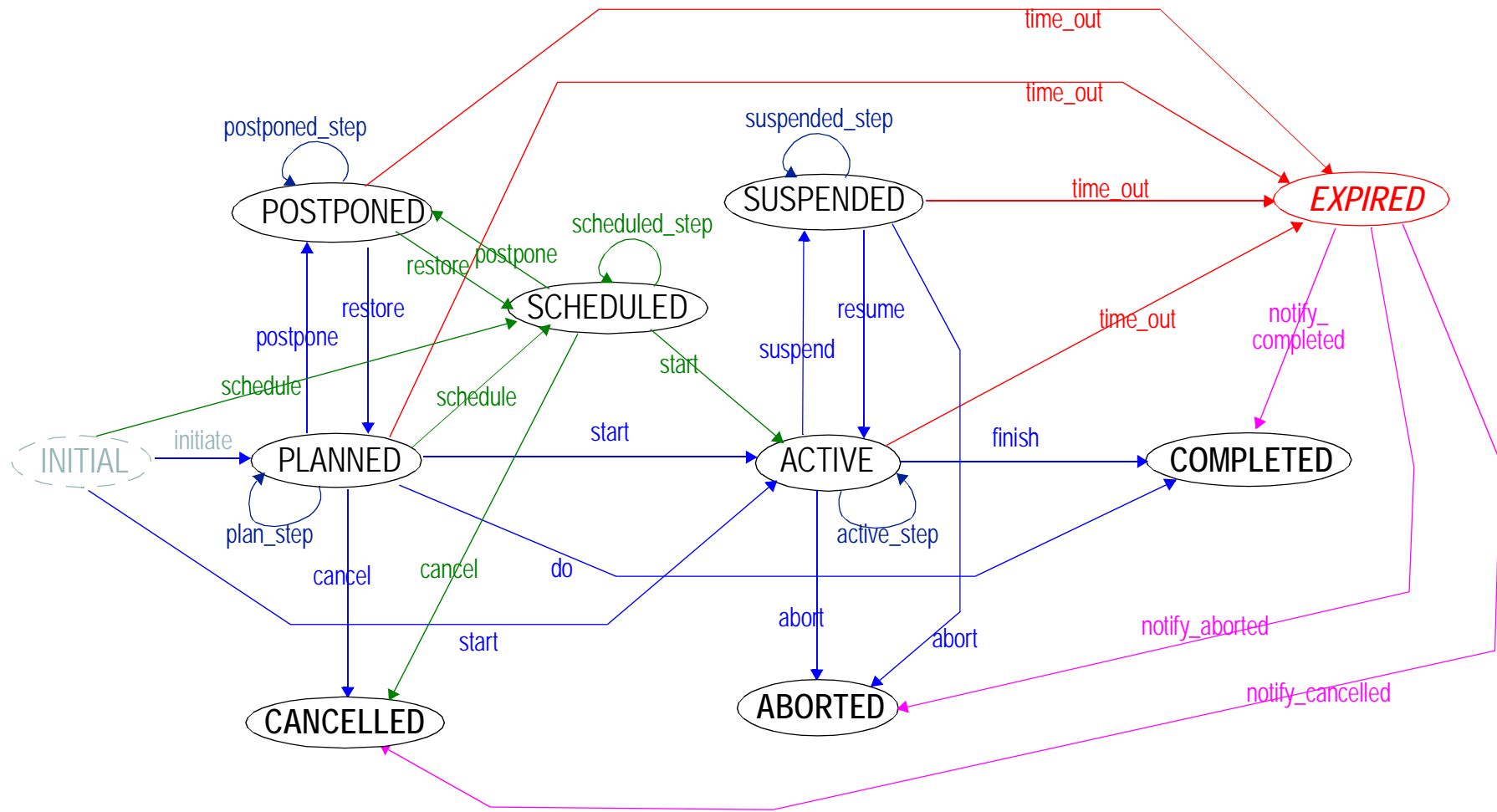

Transition legend

blue: normal state changing event	red: time-out event
dark blue: normal non-state changing event	magenta: post time-out event
green: scheduling-related transitions	

FIGURE 24 openEHR standard Instruction State Machine

The transitions are self-explanatory for the most part, however a few deserve comment. The *start* and *finish* events correspond to situations when the administration is not instantaneous, as is the situation with most medications. The *do* event is equivalent to the *finish* event occurring immediately after the *start* event, corresponding to an instantaneous administration, completion of which puts the whole Instruction in the completed state. A single shot vaccination or patient taking a single tablet are typical examples. The states `PLANNED`, `POSTPONED`, `ACTIVE`, `SUSPENDED`, each have a `xxx_step` transition which return the state machine to the same state. Workflow steps that cause no transition are mapped to these events and thus leave the Instruction in the same state. An example is a medication review, which will leave the medication in the `ACTIVE` state, if the physician chooses to continue.

In the future, if delegation of an Instruction to another Instruction is required, nesting of a new Instruction state machine within the Active state of a previous one might need to be supported.

The state machine states and transition names are defined in the *openEHR* terminology groups “ISM states” and “ISM transitions” respectively.

9.2.5.5 Careflow Process to State Machine Mapping

From a health professional’s point of view, a healthcare workflow, or “careflow”, consists of steps and events designed to meet one or more goals. The steps are highly dependent on the particular kind of workflow, and will usually be named in terms familiar to the relevant kinds of clinical professionals, such as “prescribe”, “book”, “suspend” and so on (note that some of these names may be the same as ISM transitions, but may or may not indicate the same thing). However, the need of users of health information is to know what state the execution of an Instruction is in, regardless of which particular careflow step might have just been executed. This is achieved by defining the mapping between the steps of a particular careflow to the states of the ISM in the archetype for the Instruction. When each Action corresponding to a particular Instruction is performed, it will be known both which careflow step it corresponds to and which ISM state the Instruction is now in. The following table provides an example of the mapping for a UK GP medication order workflow.

UK GP Workflow Step	State machine transition
Start	initiate (initial -> planned)
Prescribe	planned_step (planned -> planned)
Dispense	start (planned -> active)
Administer	active_step (active -> active)
Request Renewal	active_step (active -> active)
Re-issue	active_step (active -> active)
Review	active_step (active -> active)
Finish	finish (active -> completed)
Cancel	abort (active -> aborted)

Mappings like this are specified in the archetypes for the Instruction. When an `ACTION` instance is committed to the EHR, the `ISM_DETAILS` object records the step performed and the ISM state and transition. The careflow step must be one of the steps from the corresponding Instruction. See Relationship to Archetypes on page 64 for details of how archetypes are used to represent such mappings.

9.2.5.6 Clinical Workflow Definition

Clinical workflows exist at multiple hierarchical levels, from the health system level (reduce diabetes costs; manage obesity) to the fine-grained (asthmatic medication prescription for a particular patient). At all levels, there are goals, actors and tasks designed to satisfy the goals. At a coarse-grained busi-

ness process level, workflows may be enacted by more than one actor, and may encompass the whole cycle of Observation, Diagnosis, Instruction and Action. For example a workflow describing the steps “prescribe”, “dispense”, “administer”, “repeat”, “review” and so on, around a medication order might include GP, pharmacist, patient as actors. At the finer level of an actual drug or therapy administration, there is usually a single agent or group that performs a specific task, usually within one provider institution, or at home. The correspondence between workflows at these different levels and *particular* patients, rather than just categories of patients (e.g. all insulin-dependent diabetics), typically increases at finer levels of granularity. Thus from the point of view of automation, it is likely to be fine-grained workflows that have patient-specific definitions which would reasonably appear in the EHR. Most typical medication administrations are in this category. How automated workflow definitions at higher levels of organisational hierarchy are represented and coordinated with lower-level automated workflows is known to be a difficult problem generally, and given that health computing is generally more complex than most domains, implementation of distributed, coordinated (or “orchestrated” or “choreographed”, to use the terms of the workflow community) clinical workflows is likely to be some years off.

In this context, the possible scope for formal workflow definition in *openEHR* appears to be as follows.

- To enable the recording of links between *openEHR* Entries and workflow executions, e.g. a particular guideline. This allows *openEHR* data to be integrated with coarse-grained non-patient specific workflows.
- To support a standardised, interoperable representation of fine-grained formal workflow definitions for activities like medication administration.
- To use formal workflow definitions only where automation is actually useful, and is likely to be used. The kind of workflows that are likely to be worth automating are those which run over several days, weeks or longer, i.e. where humans might easily forget to perform a step. In these cases, the output of the workflow system will be reminders for humans to do certain things at certain times, rather than direct machine automation of the task. Execution of such workflow definitions will generate entries in “worklists” for staff or other agents to perform. Examples include asthma drug management for a child and PAP recall management.
- To ensure that any workflow definition takes account of other existing clinical activities, i.e. does not attempt to define all activities that might possibly be relevant. A simple example is a workflow for asthma medication administration probably does not need to explicitly model the taking of peak flow measurements, since this would normally be occurring anyway.

There are various technical challenges with proposing a standard workflow formalism for clinical use. Firstly, executable workflow definitions are essentially structured programs, similar to programs in procedural languages, but with the addition of temporal logic operators, including alternative paths, parallel paths, wait operations, and also references to outside data sources and services. Recent work in clinical workflow modelling e.g. [9], [1], [7] appears to favour a structural (i.e. parse-tree) approach to representation, due to the need to compute potential modifications to an executing workflow, including dropping, replacing and moving nodes. (Whether such “live” modification of executing workflows is realistic from the designer’s point of view might be questionable, since it means that the design of each workflow has include every possible exceptional case at a detailed level.)

Secondly, the need to connect workflows to the outside world, i.e. data sources and services like notification and worklist management is crucial in making workflows and guidelines implementable.

This problem is probably the main weakness of all guideline and workflow languages to date, including Arden, GLIF, and the various workflow languages such as those mentioned earlier.

The approach taken by the current release of *openEHR* in representing computable workflow is the following.

- Where used at all, formal workflow definitions are expressed in terms of syntax, not structures, since syntax is always a more appropriate representation for persistence (just as object structures, i.e. parse trees are more appropriate for computation).
- Access to patient data items are expressed within the syntax as symbolic queries.
- Actions, such as requests to the notification service are represented as symbolic commands.

The entire definition of a workflow is expressed as an optional parsable string, in the *wf_definition*:
DV_PARSABLE attribute of the INSTRUCTION class. Any syntax may currently be used. A workflow syntax is under development by the *openEHR* Foundation, which is designed to incorporate the relevant features of current workflow models and research, while integrating it into the *openEHR* type system and archetype framework. In particular, early versions of this syntax will show how patient data access and service commands can be expressed.

9.2.5.7 Relationship to Archetypes

Much of the semantics of particular Instructions and Actions derive from archetypes. Currently, archetypes are used to define two groups of Instruction semantics. The first is the descriptions of activities that are defined in Instructions (*ACTIVITY.description*) and executed in Actions (*ACTION.description*). These descriptions are always of the same form for any given Instruction, and it is highly desirable to have the same archetype component for both. An example is where the description is of a medication, commonly consisting of a tree or list of ten or more elements describing the drug, its name, form, dose, route and so on. The same information structure is needed in the Instruction, where it defines what is to be administered, and in the Action, where it describes what has been administered. In any particular instance, there may be small differences in what was administered (e.g. dose or route are modified) even though the archetype model will be the same for both.

In terms of archetypes therefore, definition of say two ACTIVITIES in an INSTRUCTION (see example illustrated in FIGURE 25) will actually create separate archetypes of the Activity structures, each of which will be one of the subtypes of ITEM_STRUCTURE (since this is the type of *ACTIVITY.description* and *ACTION.description*). The archetypes will then be used by both the INSTRUCTION archetype and the ACTION archetype, via the archetype slot mechanism (i.e. the standard way of composing archetypes from other archetypes; see *use_archetype* statements in FIGURE 25).

The second category of archetypable semantics is the correspondence between steps in a healthcare business process and the standard instruction state machine, as described above. This mapping is an archetype of the *ism_transition* attribute of an ACTION attribute, and therefore defines part of the ACTION archetype. FIGURE 25 shows how logical archetype elements in the archetyped editor environment corresponds to the resulting archetypes.

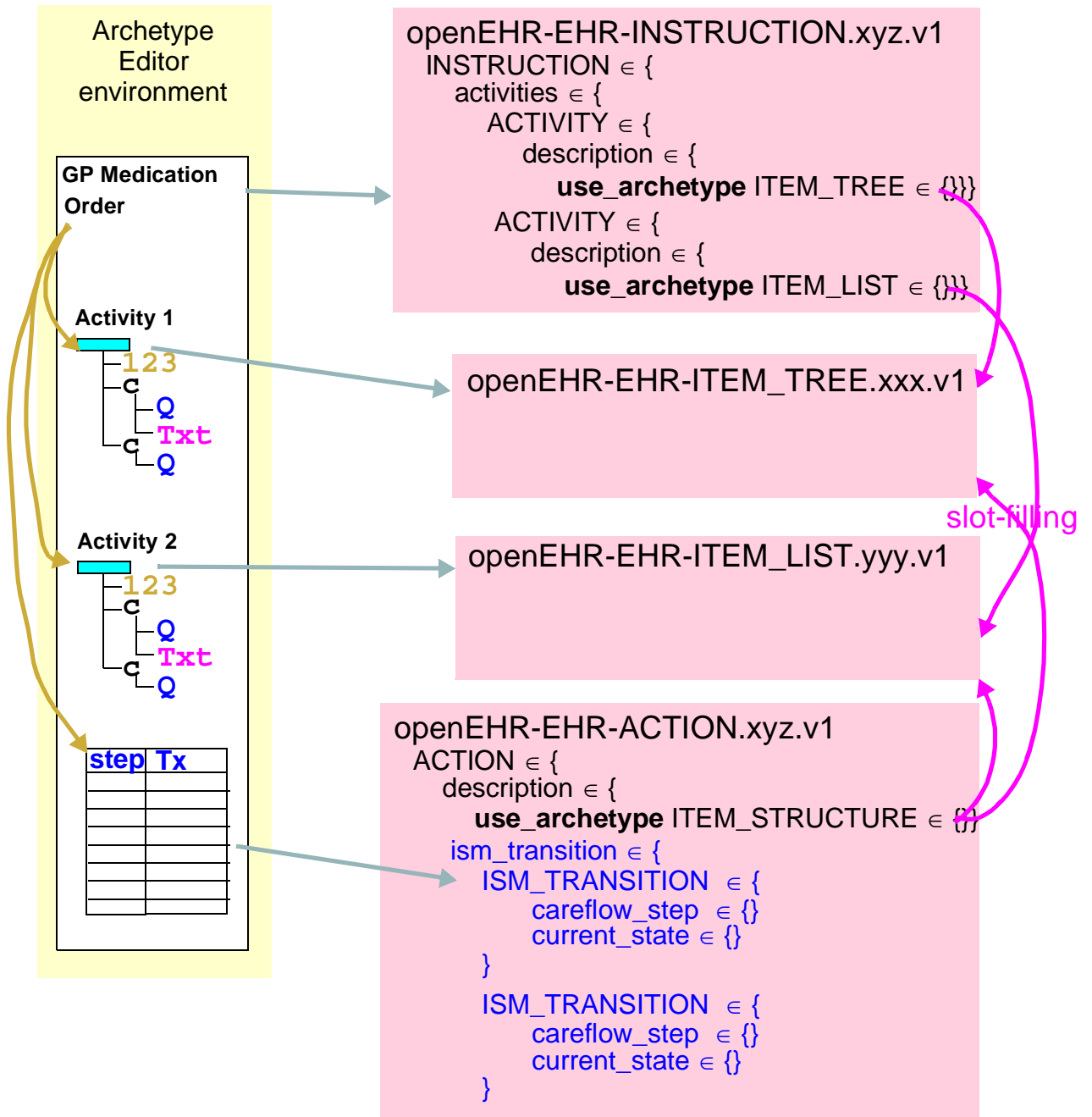

FIGURE 25 Archetypes, Instruction, and Action

9.3 Class Descriptions

9.3.1 ENTRY Class

CLASS	ENTRY (abstract)	
Purpose	<p>The abstract parent of all ENTRY subtypes. An ENTRY is the root of a logical item of “hard” clinical information created in the “clinical statement” context, within a clinical session. There can be numerous such contexts in a clinical session. Observations and other Entry types only ever document information captured/created in the event documented by the enclosing Composition.</p> <p>An ENTRY is also the minimal unit of information any query should return, since a whole ENTRY (including subparts) records spatial structure, timing information, and contextual information, as well as the subject and generator of the information.</p>	
CEN	Cluster OCC (ENV 13606:2000); Entry (prEN 13606:2006)	
OMG HDTF	COAS::HealthRecordEntry and COAS::ObservationQualifier, a generic class which is used to represent context attributes which are concretely modelled here.	
Synapses	The Item class is the closest match for Entry as described here.	
GEHR	*_CONTENT	
HL7v3	Act	
Inherit	CONTENT_ITEM	
Attributes	Signature	Meaning
1..1	language: CODE_PHRASE	Mandatory indicator of the localised language in which this Entry is written. Coded from <i>openEHR</i> Code Set “languages”.
1..1	encoding: CODE_PHRASE	Name of character set in which text values in this Entry are encoded. Coded from <i>openEHR</i> Code Set “character sets”.
1..1	subject: PARTY_PROXY	Id of human subject of this ENTRY, e.g.: <ul style="list-style-type: none"> • organ donor • foetus • a family member • another clinically relevant person.

CLASS	ENTRY (<i>abstract</i>)	
0..1	provider: PARTY_PROXY	Optional identification of provider of the informatoin in this ENTRY, which might be: <ul style="list-style-type: none"> • the patient • a patient agent, e.g. parent, guardian • the clinician • a device or software Generally only used when the recorder needs to make it explicit. Otherwise, Composition composer and other participants are assumed.
0..1	other_participations: List <PARTICIPATION>	Other participations at ENTRY level.
0..1	workflow_id: OBJECT_REF	Identifier of externally held workflow engine data for this workflow execution, for this subject of care.
Functions	Signature	Meaning
1..1	subject_is_self: Boolean	Returns True if this Entry is about the subject of the EHR, in which case the <i>subject</i> attribute is of type PARTY_SELF.
Invariants	<p>Language_valid: language /= Void and then code_set(“languages”).has(language)</p> <p>Encoding_valid: encoding /= Void and then code_set(“character sets”).has(encoding)</p> <p>Subject_validity: subject_is_self implies subject.generating_type = “PARTY_SELF”</p> <p>Other_participations_valid: other_participations /= Void implies not other_participations.is_empty</p> <p>Archetype_root_point: is_archetype_root</p>	

9.3.2 ADMIN_ENTRY Class

CLASS	ADMIN_ENTRY	
Purpose	Entry subtype for administrative information, i.e. information about setting up the clinical process, but not itself clinically relevant. Archetypes will define contained information.	
Use	Used for admistrative details of admission, episode, ward location, discharge, appointment (if not stored in a practice management or appointments system).	
Misuse	Not used for any clinically significant information.	
Inherit	ENTRY	
Attributes	Signature	Meaning

CLASS	ADMIN_ENTRY	
1..1	data: ITEM_STRUCTURE	The data of the Entry; modelled in archetypes.
Invariants	<i>Data_valid:</i> data /= Void	

9.3.3 CARE_ENTRY Class

CLASS	CARE_ENTRY (abstract)	
Purpose	The abstract parent of all clinical ENTRY subtypes. A CARE_ENTRY defines protocol and guideline attributes for all clinical Entry subtypes.	
Inherit	ENTRY	
Attributes	Signature	Meaning
0..1	protocol: ITEM_STRUCTURE	Description of the method (i.e. <i>how</i>) the information in this entry was arrived at. For OBSERVATIONS, this is a description of the method or instrument used. For EVALUATIONS, how the evaluation was arrived at. For INSTRUCTIONS, how to execute the Instruction. This may take the form of references to guidelines, including manually followed and executable; knowledge references such as a paper in Medline; clinical reasons within a largercare process.
0..1	guideline_id: OBJECT_REF	Optional external identifier of guideline creating this action if relevant
Invariants		

9.3.4 OBSERVATION Class

CLASS	OBSERVATION
Purpose	Entry subtype for all clinical data in the past or present, i.e. which (by the time it is recorded) has already occurred. OBSERVATION data is expressed using the class HISTORY<T>, which guarantees that it is situated in time.
Use	OBSERVATION is used for all notionally objective (i.e. measured in some way) observations of phenomena, and patient-reported phenomena, e.g. pain.
MisUse	Not used for recording opinion or future statements of any kind, including instructions, intentions, plans etc.
CEN	Cluster

CLASS	OBSERVATION	
GEHR	G1_OBSERVATION_CONTENT, G1_SUBJECTIVE_CONTENT	
HL7v3	Observation	
Inherit	CARE_ENTRY	
Attributes	Signature	Meaning
1..1	data: HISTORY <ITEM_STRUCTURE>	The data of this observation, in the form of a history of values which may be of any complexity.
0..1	state: HISTORY <ITEM_STRUCTURE>	Optional recording of the state of subject of this observation during the observation process, in the form of a separate history of values which may be of any complexity. State may also be recorded within the History of the <i>data</i> attribute.
Invariants	<i>Data_valid</i> : data /= Void	

9.3.5 EVALUATION Class

CLASS	EVALUATION	
Purpose	Entry type for evaluation statements.	
Use	Used for all kinds of statements which evaluate other information, such as interpretations of observations, diagnoses, differential diagnoses, hypotheses, risk assessments, goals and plans.	
MisUse	Should not be used for actionable statements such as medication orders - these are represented using the INSTRUCTION type.	
GEHR	G1_SUBJECTIVE_CONTENT	
HL7v3	In HL7v3, diagnoses etc seem to be Observations.	
Inherit	CARE_ENTRY	
Attributes	Signature	Meaning
1..1	data: ITEM_STRUCTURE	The data of this evaluation, in the form of a spatial data structure.
Invariants	<i>Data_valid</i> : data /= Void	

9.3.6 INSTRUCTION Class

CLASS	INSTRUCTION	
Purpose	Used to specify actions in the future. Enables simple and complex specifications to be expressed, including in a fully-computable workflow form.	
Use	Used for any actionable statement such as medication and therapeutic orders, monitoring, recall and review. Enough details must be provided for the specification to be directly executed by an actor, either human or machine.	
Misuse	Not to be used for plan items which are only specified in general terms.	
GEHR	G1_INSTRUCTION	
HL7v3	Act subtype Substance_administration, any Act type which is really an action specification (cf an Act in the past)	
Inherit	CARE_ENTRY	
Attributes	Signature	Meaning
1..1	narrative: DV_TEXT	Mandatory human-readable version of what the Instruction is about.
0..1	activities: List<ACTIVITY>	List of all activities in Instruction.
0..1	expiry_time: DV_DATE_TIME	Optional expiry date/time to assist determination of when an Instruction can be assumed to have expired. This helps prevent false listing of Instructions as Active when they clearly must have been terminated in some way or other.
0..1	wf_definition: DV_PARSABLE	Optional workflow engine executable expression of the Instruction.
Invariants	<i>Narrative_valid:</i> narrative /= Void <i>Activities_valid:</i> activities /= Void implies not activities.is_empty	

9.3.7 ACTIVITY Class

CLASS	ACTIVITY	
Purpose	Defines a single activity within an Instruction, such as a medication administration.	
Inherit	LOCATABLE	
Attributes	Signature	Meaning

CLASS	ACTIVITY	
1..1	description: ITEM_STRUCTURE	Description of the activity, in the form of an archetype structure.
1..1	timing: DV_PARSABLE	Timing of the activity, in the form of a parsable string, such as a GTS or iCal string.
Invariants	<i>Description_valid</i> : description /= Void <i>Timing_valid</i> : timing /= Void	

9.3.8 ACTION Class

CLASS	ACTION	
Purpose	Used to record a clinical action that has been performed, which may have been <i>ad hoc</i> , or due to the execution of an Activity in an Instruction workflow. Every Action corresponds to a careflow step of some kind or another.	
Inherit	CARE_ENTRY	
Attributes	Signature	Meaning
1..1	time: DV_DATE_TIME	Point in time at which this action completed.
1..1	description: ITEM_STRUCTURE	Description of the activity to be performed, in the form of an archetyped structure.
1..1	ism_transition: ISM_TRANSITION	Details of transition in the Instruction state machine caused by this Action.
0..1	instruction_details: INSTRUCTION_DETAILS	Details to of the Instruction that caused this Action to be performed, if there was one.
Invariants	<i>Time_valid</i> : time /= Void <i>Description_valid</i> : description /= Void <i>Ism_transition_valid</i> : ism_transition /= Void	

9.3.9 INSTRUCTION_DETAILS Class

CLASS	INSTRUCTION_DETAILS	
Purpose	Used to record details of the Instruction causing an Action.	
Inherit	LOCATABLE	
Attributes	Signature	Meaning
1..1	instruction_id: OBJECT_VERSION_ID	Id of causing Instruction.

CLASS	INSTRUCTION_DETAILS	
1..1	activity_id: String	Identifier of Activity within Instruction, in the form of its archetype path.
0..1	wf_details: ITEM_STRUCTURE	Various workflow engine state details, potentially including such things as: <ul style="list-style-type: none"> • condition that fired to cause this Action to be done (with actual variables substituted); • list of notifications which actually occurred (with all variables substituted); • other workflow engine state. This specification does not currently define the actual structure or semantics of this field.
Invariants	<i>Instruction_id_valid:</i> instruction_id /= Void <i>Activity_path_valid:</i> activity_id /= Void and then not activity_id.is_empty	

9.3.10 ISM_TRANSITION Class

CLASS	ISM_TRANSITION	
Purpose	Model of a transition in the Instruction State machine, caused by a careflow step. The attributes document the careflow step as well as the ISM transition.	
Inherit	LOCATABLE	
Attributes	Signature	Meaning
1..1	current_state: DV_CODED_TEXT	The ISM current state. Coded by <i>openEHR</i> terminology group “ISM states”.
0..1	transition: DV_CODED_TEXT	The ISM transition which occurred to arrive in the <i>current_state</i> . Coded by <i>openEHR</i> terminology group “ISM transitions”.
0..1	careflow_step: DV_CODED_TEXT	The step in the careflow process which occurred as part of generating this action, e.g. “dispense”, “start_administration”. This attribute represents the clinical label for the activity, as opposed to <i>current_state</i> which represents the state machine (ISM) computable form. Defined in archetype.
Invariants	<i>Current_state_valid:</i> current_state /= Void and then terminology(“openehr”).codes_for_group_name(“ISM states”, “en”).has(current_state.defining_code) <i>Transition_valid:</i> transition /= Void implies terminology(“openehr”).codes_for_group_name(“ISM transitions”, “en”).has(transition.defining_code)	

9.4 Instance Structures

The following subsections illustrate typical Entry instance structures. For guidance on how to best model particular clinical statements, see the archetype part of the *openEHR* knowledge repository (http://svn.openehr.org/knowledge/project_page.htm).

9.4.1 OBSERVATION

Heartrate Measurement Series

FIGURE 26 illustrates three heartrate measurements over 10 minutes.

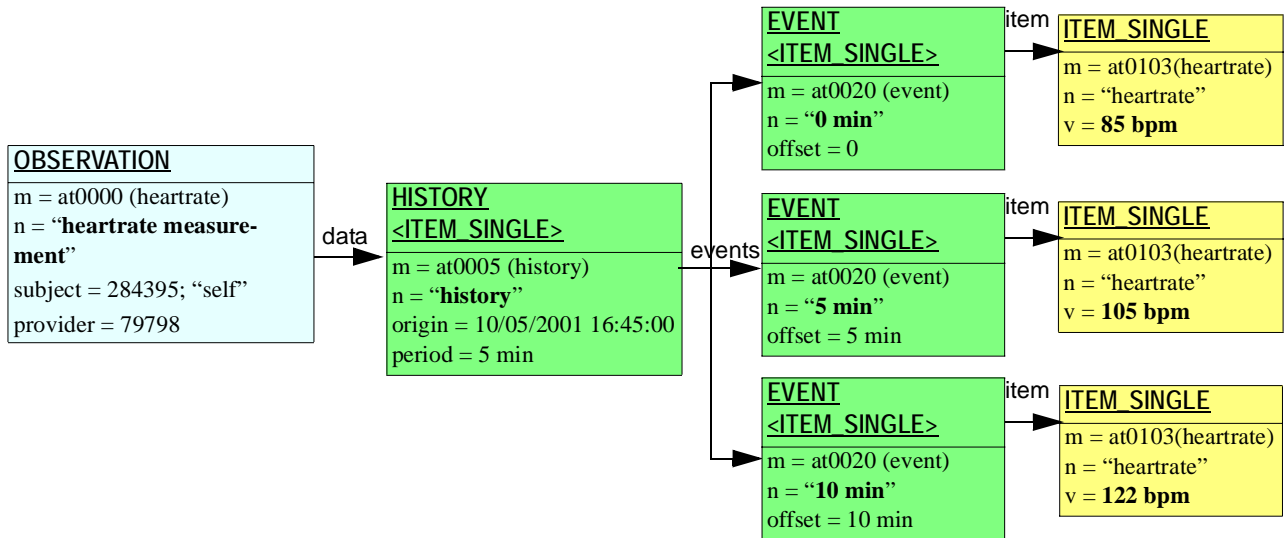

FIGURE 26 Periodic series Instance Structure

Blood Pressure with Protocol

FIGURE 27 illustrates a blood pressure observation with protocol.

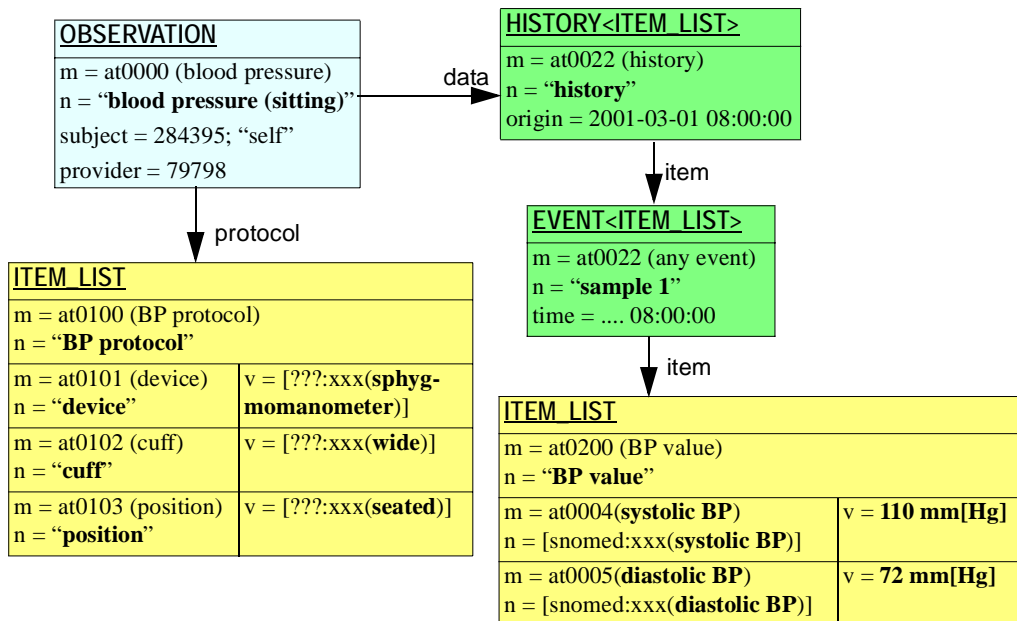

FIGURE 27 Blood Pressure Measurement Observation

Glucose Tolerance Test

An oral glucose tolerance test takes the following form, although the number and timing of the blood sugar levels may be slightly different in practice:

- challenge: no calories fasting from 12pm to 8am
- datum: BSL - 8am
- challenge: 75 g glucose orally - 8:01 am
- datum: BSL - 9 am
- datum: BSL - 10 am

OGTT is treated as a single clinical concept, and thus requires only one archetype. A typical instance structure is shown in FIGURE 28. In this example, the three blood sugars are represented by EVENTS, with the fasting and glucose challenges being expressed as states on the relevant events.

9.4.2 EVALUATION

Partial Asthma Management Plan

FIGURE 29 illustrates a partial asthma management plan in which monitoring (peak flow) with dependent actions (review and admission to ER) and therapy (bronchodilator) are shown. In a complete plan, symptom monitoring and other medications might be shown. The parts of the plan are

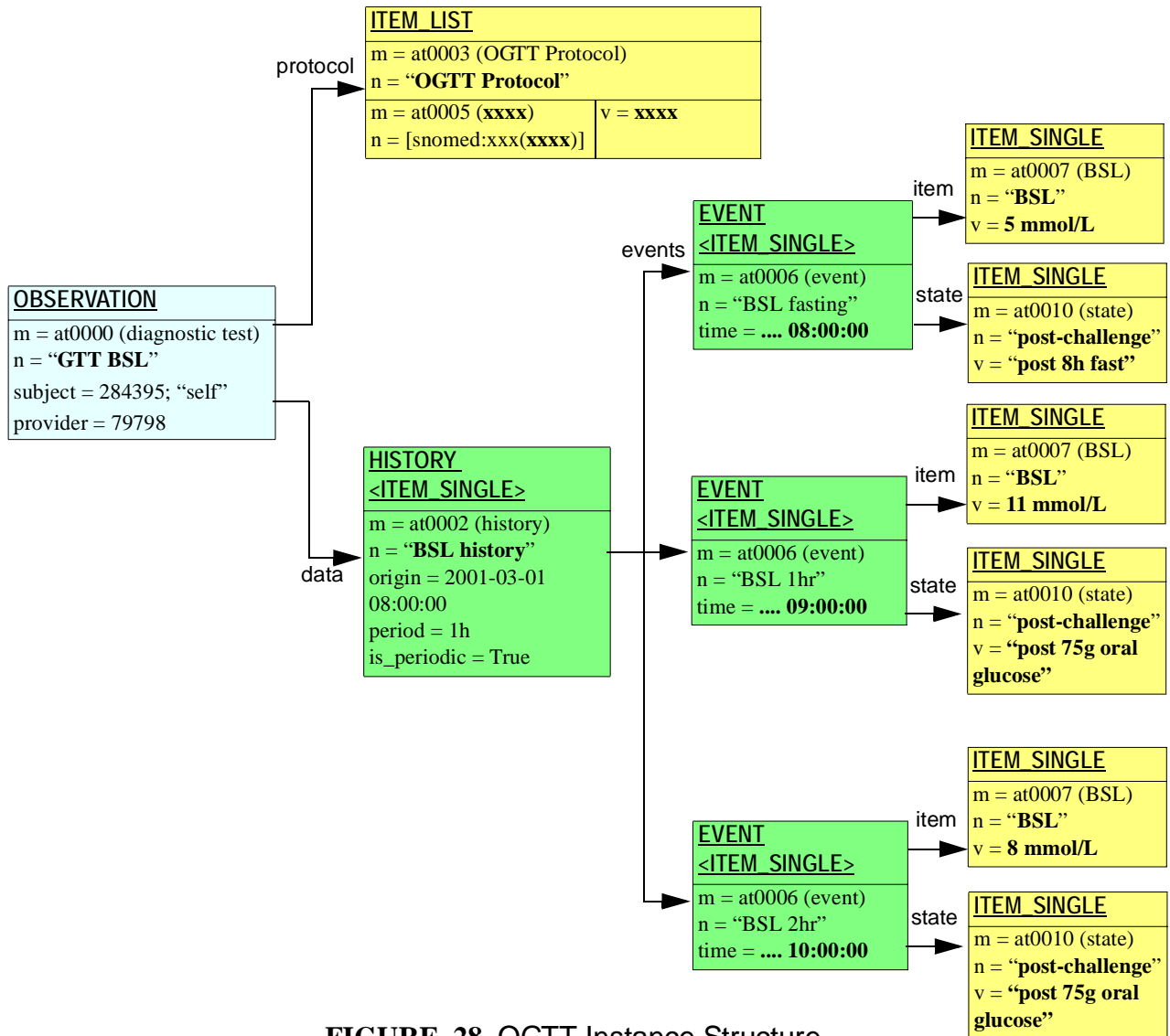

FIGURE 28 OGTT Instance Structure

linked to the root EVALUATION node via the *links*: Set<LINK> attribute inherited from the LOCATA-BLE class.

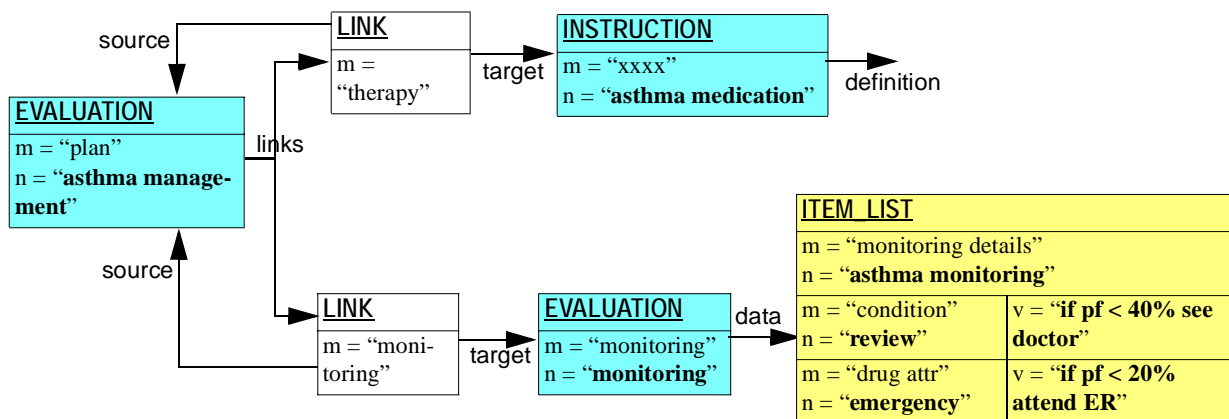

FIGURE 29 Partial Asthma Management Plan

9.4.3 INSTRUCTION

Chained Medication Order

Often, a medication order for one drug consists of segments in which one or more of the administration details of route, form, frequency, dose etc is changed. In hospitals, intravenous antibiotics and pain relief drugs may be followed by a tablet form of the same drug to be taken orally. Other examples are common in general practice, such as the following order:

- trade name = Panafcortelone; generic name = Prednisolone; form = tablets; dose = 25mg; route = oral; freq = bd x 3 days; od x 2 days.

FIGURE 30 illustrates the instance structure for this Instruction. Note that the *timing* attribute of the ACTIVITY instance is shown in human-readable form; in reality it will be a GTS string or similar (see Timing Specification section of *openEHR Data Types IM*).

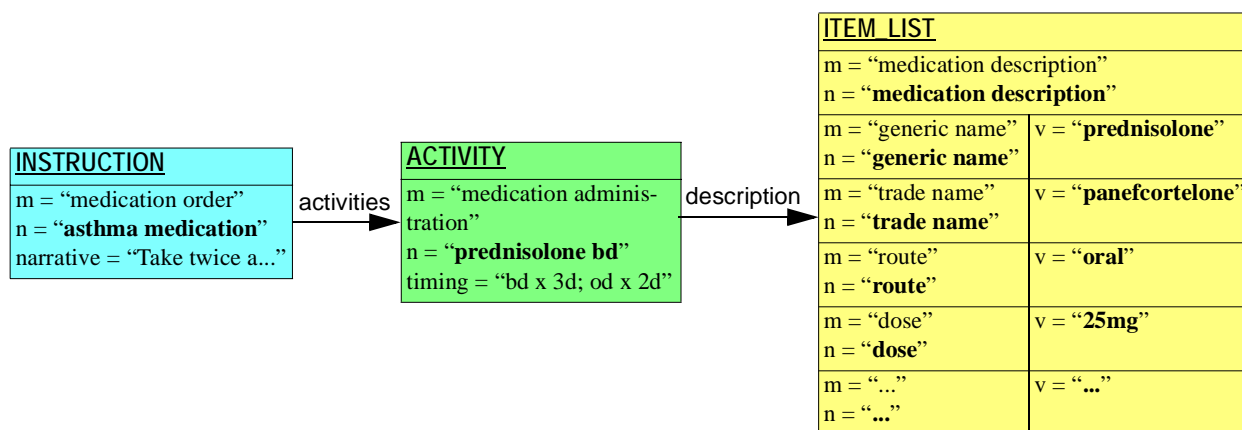

FIGURE 30 Chained medication order

Multi-drug Therapy

A common regime for treating duodenal ulcer and related complaints is using Losec with other drugs, such as in the following combination:

- Losec 40 mg od x 4w or until no symptoms
- amoxicillin 500 mg 3td x 7d
- metronidazole 400 mg 3td x 7d

The Instruction for this therapy is illustrated in FIGURE 31.

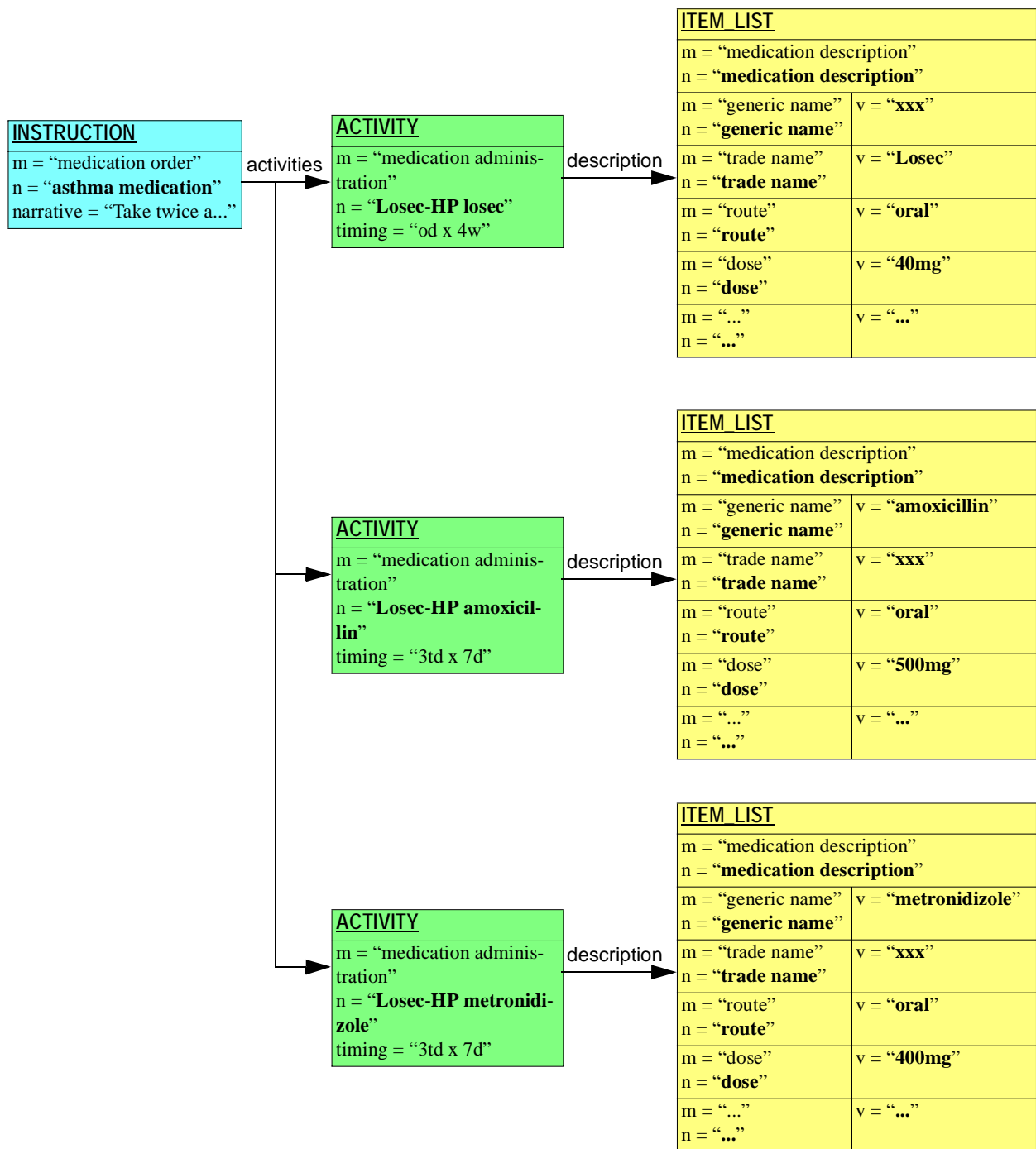

FIGURE 31 Multi-drug therapy Instruction

A Glossary

A.1 *openEHR* Terms

HCA	Health care agent - any doctor, nurse or other recognised staff member, or software or device
HCF	Health care facility - any place where EHRs are kept
HCP	Health care professional - any doctor, nurse or other recognised staff member of an HCF

A.2 Clinical Terms

Care Pathway	A global care management strategy for a patient, showing management of health problems or issues in a time-based framework, similar to a project management view of an engineering work.
Contribution	
Episode	A series of clinical events linked in time, such as a hospital admission or a surgical episode.
Event	
Extract	
Issue	A problem as identified by the patient, e.g. "inability to do exercise due to breathing difficulty"; may be the object of wider health care, e.g. social workers, physiotherapists etc.
Section	
Problem	A health problem of the patient, as identified by its underlying medical cause, e.g. asthma; the object of medical care.
Composition	

A.3 IT Terms

.NET	
API	Application programmer's interface - the software interface to a library or module.
COM	Microsoft's Component Object Model; designed to enable integration of binary components obeying stated exported interfaces.
CORBA	Common Object Request Broker Architecture - an object-oriented middleware architecture enabling the construction of 3-tier systems, in which backend data providers (DBMSs etc) are known only by the services they export to the network. CORBA is an open standard managed by the Object Management Group (OMG).
DCOM	Distributed version of Microsoft COM. Similar in its aim to CORBA.
J2EE	
ODMG-93	A standard for object databases, which includes an object definition language (ODL) for writing schemas, an object query language (OQL) for querying, and several language bindings

B References

B.1 General

- 1 Barretto S A. *Designing Guideline-based Workflow-Integrated Electronic Health Records*. 2005. PhD dissertation, University of South Australia. Available at http://www.cis.unisa.edu.au/~cissab/Barretto_PhD_Thesis_Revised_FINAL.pdf.
- 2 Berners-Lee T. "Universal Resource Identifiers in WWW". Available at <http://www.ietf.org/rfc/rfc2396.txt>. This is a World-Wide Web RFC for global identification of resources. In current use on the web, e.g. by Mosaic, Netscape and similar tools. See <http://www.w3.org/Addressing> for a starting point on URIs.
- 3 Beale T. *Archetypes: Constraint-based Domain Models for Future-proof Information Systems*. See <http://www.deepthought.com.au/it/archetypes.html>.
- 4 Beale T, Heard S. *A Systematic Theory of Clinical Recording*. 2006. Publication to be announced.
- 5 Beale T, Heard S. *A Model of Clinical Context for EHR Recording*. 2006. Publishing to be announced.
- 6 Beale T. *An Ontological Framework for Understanding Clinical Information*. 2006. Publishing to be announced.
- 7 Browne E D. *Workflow Modelling of Coordinated Inter-Health-Provider Care Plans*. 2005. PhD dissertation, University of South Australia. Available at XXXXXXXXXXXXXXXX.
- 8 Gray J, Reuter A. *Transaction Processing Concepts and Techniques*. Morgan Kaufmann 1993.
- 9 Müller R. *Event-oriented Dynamic Adaptation of Workflows: Model, Architecture, and Implementation*. 2003. PhD dissertation, University of Leipzig. Available at XXXXXXXXXXXXXXXX.
- 10 Rector A L, Nowlan W A, Kay S. *Foundations for an Electronic Medical Record*. The IMIA Yearbook of Medical Informatics 1992 (Eds. van Bommel J, McRay A). Stuttgart Schattauer 1994.
- 11 Rossi-Mori A, Consorti F. *Assembling clinical information*. Note sent to HL7v3 discussion list, 2001-04-19.
- 12 Sowa J F. *Knowledge Representation: Logical, philosophical and Computational Foundations*. 2000, Brooks/Cole, California.
- 13 Schloeffel P. (Editor). *Requirements for an Electronic Health Record Reference Architecture*. International Standards Organisation, Australia; Feb 2002; ISO TC 215/SC N; ISO/WD 18308.
- 14 Sottile P.A., Ferrara F.M., Grimson W., Kalra D., and Scherrer J.R. *The holistic healthcare information system*. Toward an Electronic Health Record Europe 1999. Nov 1999; 259-266.
- 15 Van de Velde R, Degoulet P. *Clinical Information Systems: A Component-Based Approach*. 2003. Springer-Verlag New York.

B.2 European Projects

- 16 Dixon R., Grubb P.A., Lloyd D., and Kalra D. *Consolidated List of Requirements. EHCR Support Action Deliverable 1.4*. European Commission DGXIII, Brussels; May 2001 59pp Available from http://www.chime.ucl.ac.uk/HealthI/EHCR-SupA/del1-4v1_3.PDF.
- 17 Dixon R, Grubb P, Lloyd D. *EHCR Support Action Deliverable 3.5: "Final Recommendations to CEN for future work"*. Oct 2000. Available at <http://www.chime.ucl.ac.uk/HealthI/EHCR-SupA/documents.htm>.
- 18 Dixon R, Grubb P, Lloyd D. *EHCR Support Action Deliverable 2.4 "Guidelines on Interpretation and implementation of CEN EHCRA"*. Oct 2000. Available at <http://www.chime.ucl.ac.uk/HealthI/EHCR-SupA/documents.htm>.
- 19 Ingram D. *The Good European Health Record Project*. Laires, Laderia Christensen, Eds. health in the New Communications Age. Amsterdam: IOS Press; 1995; pp. 66-74.
- 20 Lloyd D, et al. *EHCR Support Action Deliverable 3.1&3.2 "Interim Report to CEN"*. July 1998. Available at <http://www.chime.ucl.ac.uk/HealthI/EHCR-SupA/documents.htm>.
- 21 *Deliverable 4: GEHR Requirements for Clinical Comprehensiveness*. GEHR Project 1992
- 22 *Deliverable 7: Clinical Functional Specifications*. GEHR Project 1993
- 23 *Deliverable 8: Ethical and legal Requirements of GEHR Architecture and Systems*. GEHR Project 1994
- 24 *Deliverable 19,20,24: GEHR Architecture*. GEHR Project 30/6/1995
- 25 Grimson W. and Groth T. (Editors). *The Synapses User Requirements and Functional Specification (Part B)*. EU Telematics Application Programme, Brussels; 1996; *The Synapses Project: Deliverable USER 1.1.1b*.
- 26 Kalra D. (Editor). *The Synapses User Requirements and Functional Specification (Part A)*. EU Telematics Application Programme, Brussels; 1996; *The Synapses Project: Deliverable USER 1.1.1a*. 6 chapters, 176 pages.
- 27 Kalra D. (Editor). *Synapses ODP Information Viewpoint*. EU Telematics Application Programme, Brussels; 1998; *The Synapses Project: Final Deliverable*. 10 chapters, 64 pages.

B.3 CEN

- 28 ENV 13606-1 - *Electronic healthcare record communication - Part 1: Extended architecture*. CEN/ TC 251 Health Informatics Technical Committee.
- 29 ENV 13606-2 - *Electronic healthcare record communication - Part 2: Domain term list*. CEN/ TC 251 Health Informatics Technical Committee.
- 30 ENV 13606-3 - *Electronic healthcare record communication - Part 3: Distribution rules*. CEN/ TC 251 Health Informatics Technical Committee.
- 31 ENV 13606-4 - *Electronic Healthcare Record Communication standard Part 4: Messages for the exchange of information*. CEN/ TC 251 Health Informatics Technical Committee.

B.4 GEHR Australia

- 32 Heard S. *GEHR Project Australia, GPCG Trial*. Available at <http://www.gehr.org/gpcg/ehra.htm>.
- 33 Beale T, Heard S. *GEHR Technical Requirements*. See http://www.gehr.org/technical/requirements/gehr_requirements.html.

B.5 HL7v3

- 34 Schadow G, McDonald C J. *The Unified Code for Units of Measure*, Version 1.4, April 27, 2000. Regenstrief Institute for Health Care, Indianapolis. See <http://aurora.rg.iu-pui.edu/UCUM>
- 35 Schadow G, Russler D, Mead C, Case J, McDonald C. HL7 version 3 deliverable: *The Unified Service Action Model : Documentation for the clinical area of the HL7 Reference Information Model*. (Revision 2.4+).
- 36 Schadow G, Biron P. HL7 version 3 deliverable: *Version 3 Data Types*. (DRAFT Revision 1.0).

B.6 OMG

- 37 CORBAMED document: *Person Identification Service*. (March 1999).
(Authors?)
- 38 CORBAMED document: *Clinical Observations Access Service*. (Jan 2000)
3M, Care Data Systems, CareFlow/Net, HBO & C, LANL, and others.
- 39 CORBAMED document: *Lexicon Query Service*. (March 1999)
(Authors?)

B.7 Software Engineering

- 40 Meyer B. *Object-oriented Software Construction*, 2nd Ed.
Prentice Hall 1997
- 41 Walden K, Nerson J. *Seamless Object-oriented Software Architecture*.
Prentice Hall 1994
- 42 Gamma E, Helm R, Johnson R, Vlissides J. *Design patterns of Reusable Object-oriented Software*
Addison-Wesley 1995
- 43 Fowler M. *Analysis Patterns: Reusable Object Models*
Addison Wesley 1997
- 44 Fowler M, Scott K. *UML Distilled (2nd Ed.)*
Addison Wesley Longman 2000
- 45 Booch G, Rumbaugh J, Jacobsen I. *The Unified Modelling Language User Guide*. Addison es-

ley 1999.

B.8 Resources

- 46 Arden Syntax. <http://www.cpmc.columbia.edu/arden/>
- 47 Asbru / The Asgaard Project. <http://smi-web.stanford.edu/projects/asgaard/>
- 48 Digital Imaging and Communications in Medicine (DICOM). <http://medical.nema.org/dicom.html>.
- 49 EON ref required
- 50 GLIF (Guideline Interchange Format). <http://www.glif.org/>.
- 51 IANA - <http://www.iana.org/>.
- 52 ProForma language for decision support. <http://www.acl.icnet.uk/lab/proforma.html>.
- 53 SynEx project, UCL. <http://www.chime.ucl.ac.uk/HealthI/SynEx/>.

END OF DOCUMENT